

PT9600

Cable Actuated Encoder Reel

Converts ANY Rotary Encoder to a Linear Position Sensor

Linear Stroke Range up to 550 inches (14 m)

Mates Virtually ANY Customer Supplied Encoder

Factory Supplied Encoder Available

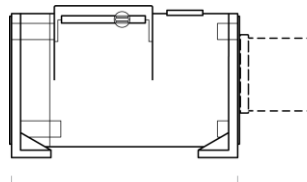

7.9" [200 mm]

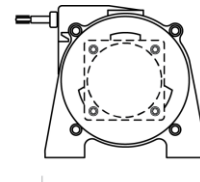

5.3" [135 mm]

Our unique string encoder module mates to virtually any encoder, giving you a cost-effective long-range linear position measurement solution that precisely fits your requirements.

This modular approach delivers the ultimate in flexibility. To order, simply select the measurement range, the cable tension and encoder mounting style—it's that easy! We even supply all the necessary encoder mounting tools and attaching hardware. If you can't find your encoder mounting style or you want us to provide the encoder, please give us a call.

General

Full Stroke Range	0-75 to 0-550 inches
Motion Conversion Ratio	12.6 inches per turn, see ordering information
Accuracy	the lesser of $\pm 0.02\%$ f.s. or $\pm 0.04\%$ measurement $\pm 1/2$ pulse
Accuracy, best	not less than 0.001 in. (0.03mm)
Repeatability	$\pm 0.02\%$ of measurement $\pm 1/2$ pulse
Measuring Cable Options	see ordering information
Module Material Options	powder-painted aluminum or stainless
Encoder Coupling	aluminum flexible coupling
Maximum Allowable Rotational Sensor Torque	1.0 in-lbs.
Maximum Retraction Acceleration	see ordering information
Maximum Velocity	see ordering information
Weight, Aluminum (Stainless Steel) Enclosure	8 lbs. (16 lbs.) max.

Environmental

Operating Temperature	-40° to 200°F (-40° to 90°C)
------------------------------	------------------------------

PT9600

Cable Reel • String Encoder

Fig. 1 – Outline Drawing (18 oz. cable tension only)

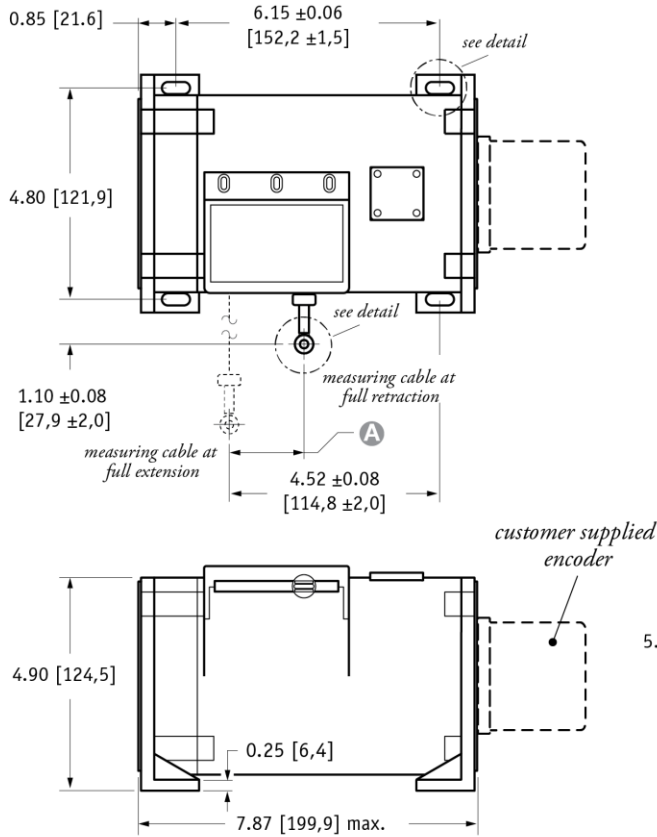

DIMENSIONS ARE IN INCHES [MM]
tolerances are 0.03 IN. [0.5 MM] unless otherwise noted.

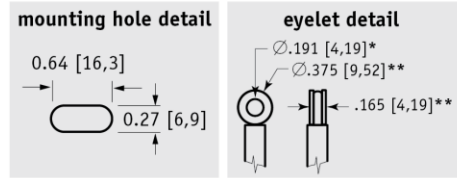

A DIMENSION (INCHES)

MEASURING CABLE				
RANGE	Ø.031 in.	Ø.034 in.	Ø.047 in.	Ø.062 in.
75	n/a	0.22	0.29	0.37
100	n/a	0.29	0.39	0.49
150	n/a	0.44	0.59	0.73
200	n/a	0.58	0.79	0.98
250	n/a	0.73	0.98	1.22
300	n/a	0.88	1.18	1.47
350	n/a	1.02	1.38	1.71
400	n/a	1.17	1.57	1.96
450	n/a	1.31	1.77	n/a
500	n/a	1.46	1.97	n/a
550	1.61	1.61	n/a	n/a

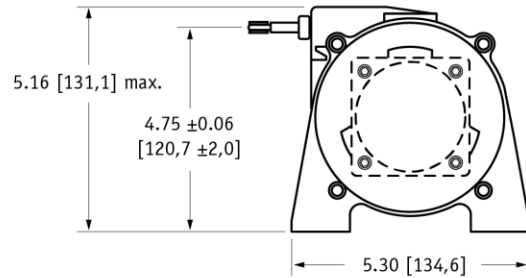

* tolerance = +.005 -.001 [+,.13 -.03]
** tolerance = +.005 -.005 [+,.13 -.13]

VLS Option - Free Release Protection

The patented Celesco Velocity Limiting System (VLS) is an option for PT9000 Series cable extension transducers that limits cable retraction to a safe 40 to 55 inches per second for the single spring option and 40 to 80 inches per second for the higher tension dual spring option.

The VLS option prevents the measuring cable from ever reaching a damaging velocity during an accidental free release. This option is ideal for mobile applications that require frequent cable disconnection and reconnection. It prevents expensive unscheduled downtime due to accidental cable mishandling or attachment failure.

1. using guide below, select PT9600 model **PT9600-0100-111-F01**
2. remove "PT" from the model number **~~PT~~ 9600-0100-111-F01**
3. add "VLS" **VLS + 9600-0100-111-F01**
4. completed model number! **VLS9600-0100-111-F01**

VLS9600-

	A	B	C	D
0075	1	1	1	F01
thru	2	2	2	F02
0550	3	3	3	S01
	4	4	4	S02
				S04

■ = available options.

PT9600

Cable Reel • String Encoder

Ordering Information

Model Number:

PT9600- _____
order code: **R** **A** **B** **C** **D**

Sample Model Number:

PT9600 - 0200 - 111 - F01

- R** range: 200 inches
- A** enclosure / cable tension: aluminum / 18 oz.
- B** measuring cable: .034 nylon-coated stainless
- C** cable exit: front
- D** rotational sensor mounting style: F01 (2.5-in. sq. flange)

Full Stroke Range:

R order code:	0075	0100	0150	0200	0250	0300	0350	0400	0450*	0500*	0550*
full stroke range, min:	75 in.	100 in.	150 in.	200 in.	250 in.	300 in.	350 in.	400 in.	450 in.	500 in.	550 in.

* -36 oz. cable tension strongly recommended

Enclosure / Measuring Cable Tension:

A order code:	1	3	2	4
tension (±30%):	18 oz.		36 oz.	
enclosure material:	<i>powder-painted aluminum</i>	<i>303 stainless steel</i>	<i>powder-painted aluminum</i>	<i>303 stainless steel</i>
max. acceleration:	1 g	1 g	5 g	5 g
max. velocity:	60 inches/sec	60 inches/sec	200 inches/sec	200 inches/sec

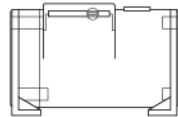

standard housing
see fig 1.

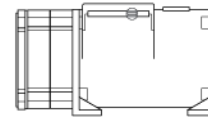

dual-spring housing
see fig 2.

Measuring Cable/ Conversion Ratio:

B order code:	1	2	3	4	
cable construction:	Ø.034-inch nylon-coated stainless steel rope	Ø.047-inch bare stainless steel rope	Ø.058-inch PVC jacketed vectra fiber rope	Ø.031-inch bare stainless steel rope	
available ranges:	<i>all ranges</i>	<i>all ranges up to 500 inches</i>	<i>all ranges up to 400 inches</i>	<i>550-inch range only</i>	
general use:	indoor	outdoor, debris, high temperature	high voltage or magnetic field	outdoor, debris, high temperature	
conversion ratio {	aluminum enclosure:	1 turn = 12.673 ± 0.016 in.	1 turn = 12.714 ± 0.016 in.	1 turn = 12.755 ± 0.016 in.	1 turn = 12.664 ± 0.016 in.
	stainless enclosure:	1 turn = 12.579 ± 0.022 in.	1 turn = 12.620 ± 0.022 in.	1 turn = 12.661 ± 0.022 in.	1 turn = 12.569 ± 0.022 in.

Cable Exit:

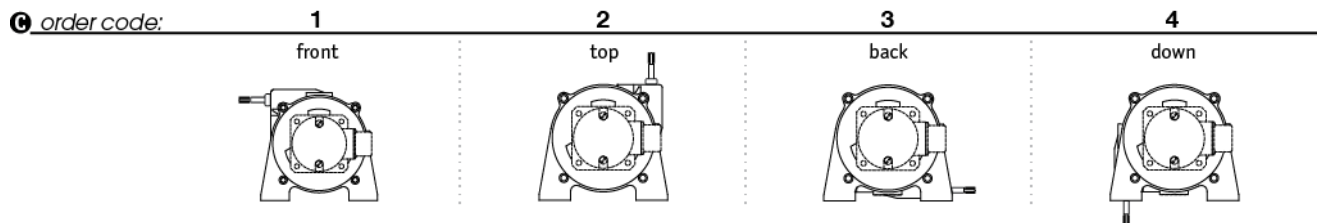

Rotational Sensor Mounting Style:

① order code:	F01	F02	S01	S02	S04
	2.5-in. Flange Mount 3/8-inch shaft	2-in. Flange Mount 3/8-inch shaft	Face-Mount 6 mm shaft M4 mounting screws	Face-Mount 10 mm shaft M4 mounting screws	Face-Mount 10 mm shaft M3 mounting screws

Note: If you don't see your encoder style, please contact factory. All encoder types supported.

F01 - 2½-inch Sq. Flange Mount (3/8-inch shaft)

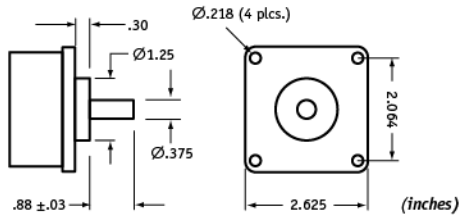

F02 - 2-inch Sq. Flange Mount (3/8-inch shaft)

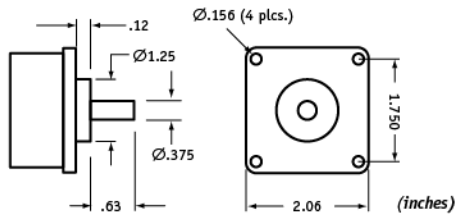

S01 - Face-Mount (6mm shaft/M4 screws)

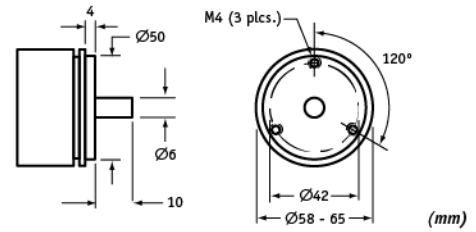

S02 - Face-Mount (10mm shaft/M4 screws)

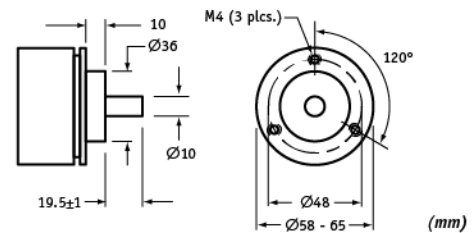

S04 - Face-Mount (10mm shaft/M3 screws)

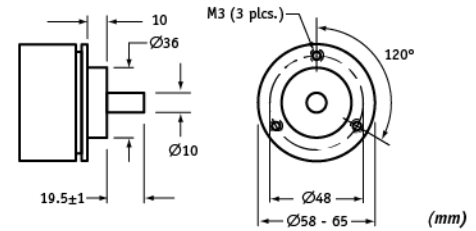

PT9600

Cable Reel • String Encoder

Fig. 2 – Outline Drawing (36 oz. cable tension only)

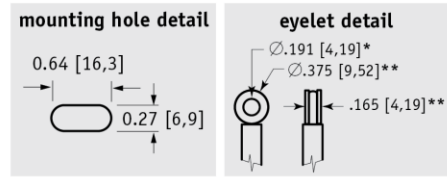
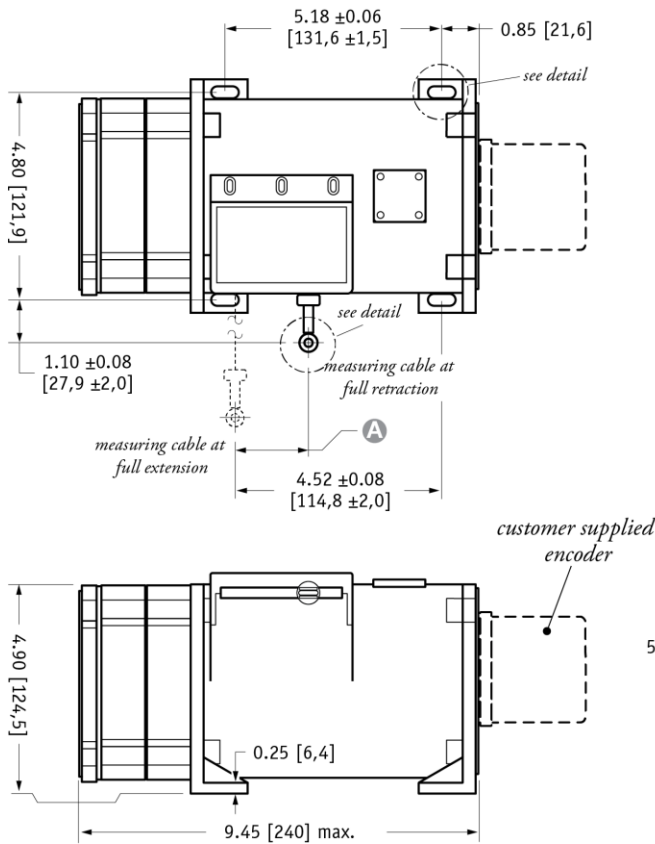

A DIMENSION (INCHES)

MEASURING CABLE				
RANGE	Ø.031 in.	Ø.034 in.	Ø.047 in.	Ø.062 in.
75	n/a	0.22	0.29	0.37
100	n/a	0.29	0.39	0.49
150	n/a	0.44	0.59	0.73
200	n/a	0.58	0.79	0.98
250	n/a	0.73	0.98	1.22
300	n/a	0.88	1.18	1.47
350	n/a	1.02	1.38	1.71
400	n/a	1.17	1.57	1.96
450	n/a	1.31	1.77	n/a
500	n/a	1.46	1.97	n/a
550	1.61	1.61	n/a	n/a

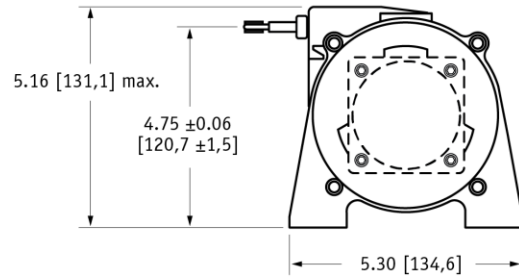

DIMENSIONS ARE IN INCHES [MM]
tolerances are 0.03 IN. [0.5 MM] unless otherwise noted.

* tolerance = +.005 -.001 [+.13 -.03]
** tolerance = +.005 -.005 [+.13 -.13]

NORTH AMERICA

Measurement Specialties, Inc.,
a TE Connectivity company
20630 Plummer Street
Chatsworth, CA 91311
Tel +1 800 423 5483
Tel +1 818 701 2750
Fax +1 818 701 2799
info@celesco.com

TE.com/sensorsolutions

Measurement Specialties, Inc., a TE Connectivity company.

Measurement Specialties, TE Connectivity, TE Connectivity (logo) and EVERY CONNECTION COUNTS are trademarks. All other logos, products and/or company names referred to herein might be trademarks of their respective owners.

The information given herein, including drawings, illustrations and schematics which are intended for illustration purposes only, is believed to be reliable. However, TE Connectivity makes no warranties as to its accuracy or completeness and disclaims any liability in connection with its use. TE Connectivity's obligations shall only be as set forth in TE Connectivity's Standard Terms and Conditions of Sale for this product and in no case will TE Connectivity be liable for any incidental, indirect or consequential damages arising out of the sale, resale, use or misuse of the product. Users of TE Connectivity products should make their own evaluation to determine the suitability of each such product for the specific application.

© 2015 TE Connectivity Ltd. family of companies All Rights Reserved.

PT9600 12/01/2015