

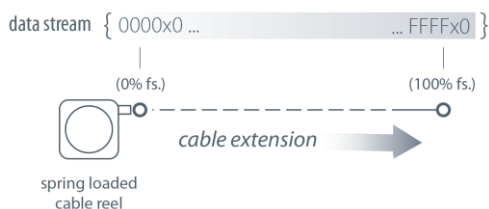

The PT8CN, using a high cycle plastic-hybrid potentiometer, communicates to your PLC via the CANbus SAE J1939 interface. Suitable for factory and harsh environment applications requiring linear position feedback in ranges up to 60".

As a member of our innovative family of NEMA 4 rated cable actuated sensors, the PT8CN installs in minutes by simply mounting its body to a fixed surface and attaching its cable to the movable object. Perfect parallel alignment not required.

### Output Signal



## PT8CN

### Cable Actuated Sensor CANbus • SAE J1939 Output Signal

#### Industrial Grade String Pot

**Absolute Linear Position to 60 inches (1524 mm)**

**Aluminum or Stainless Steel Enclosure Options**

**NEMA 6 / IP67**

#### General

<b>Full Stroke Ranges</b>	0-2 to 0-60 inches
<b>Electrical Interface</b>	CANbus SAE J1939
<b>Protocol</b>	Proprietary B
<b>Accuracy</b>	±1.0% to ±0.1% full stroke (see ordering information)
<b>Repeatability</b>	± 0.02% full stroke
<b>Resolution</b>	± 0.003% full stroke
<b>Measuring Cable</b>	stainless steel or thermoplastic
<b>Enclosure Material</b>	powder-painted aluminum or stainless steel
<b>Sensor</b>	plastic-hybrid precision potentiometer
<b>Potentiometer Cycle Life</b>	see ordering information
<b>Maximum Retraction</b>	see ordering information
<b>Acceleration</b>	
<b>Weight, Aluminum (Stainless Steel) Enclosure</b>	3 lbs. (6 lbs.), max.

#### Electrical

<b>Input Voltage</b>	7 - 18 VDC
<b>Input Current</b>	60 mA max.
<b>Baud Rate</b>	125K, 250K, or 500K via DIP switches
<b>Update Rate</b>	10 ms. (20 ms. available, contact factory)

#### Environmental

<b>Environmental Suitability</b>	NEMA 4X/6, IP 67
<b>Operating Temperature</b>	-40° to 185°F (-40° to 85°C)
<b>Vibration</b>	up to 10 g to 2000 Hz maximum

# I/O Format and Settings

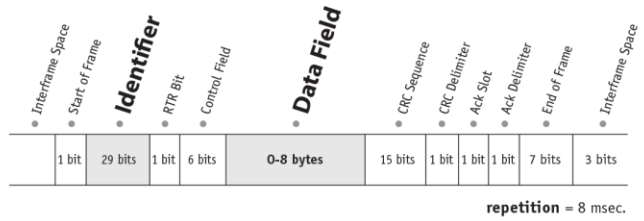

## • Identifier

	Message Priority				Future Use				J1939 Reference Proprietary B								Data Field Type*				Not Used		Node ID**											
Example -	1	0	0	0	0	0	1	1	1	1	1	1	1	1	1	1	1	0	1	0	1	0	0	1	1	0	0	1	1	1	1	1	1	1
Identifier Bit No. -	28	27	26	25	24	23	22	21	20	19	18	17	16	15	14	13	12	11	10	9	8	7	6	5	4	3	2	1	0					
Hex Value -	0				F				F				5				3				3		F											

\*Sensor field data can be factory set to customer specific value. \*\*Customer defined, set via Dips 1-6. Bit values shown for example only, see Address Setting below.

## • Data Field

**B<sub>0</sub>** = LSB current % of measurement range byte  
**B<sub>1</sub>** = MSB current % of measurement range byte  
**B<sub>2</sub>** = LSB current measurement count byte  
**B<sub>3</sub>** = MSB current measurement count byte

**B<sub>4</sub>** = error flag  
**B<sub>5</sub>** = error flag  
**B<sub>6</sub>** = LSB velocity data byte  
**B<sub>7</sub>** = MSB velocity data byte

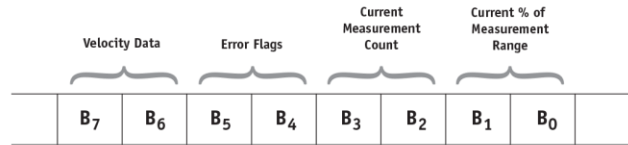

### Current Measurement Count

The **Current Measurement Count (CMC)** is the output data that indicates the present position of the measuring cable. The CMC is a 16-bit value that occupies bytes **B<sub>2</sub>** and **B<sub>3</sub>** of the data field. **B<sub>2</sub>** is the **LSB** (least significant byte) and **B<sub>3</sub>** is the **MSB** (most significant byte).

The **CMC** starts at **0x0000** with the measuring cable fully retracted and continues upward to the end of the stroke range stopping at **0xFFFF**. This holds true for all ranges.

### Converting CMC to Linear Measurement

To convert the current measurement count to inches or millimeters, simply divide the count by 65,535 (total counts over the range) and then multiply that value by the full stroke range:

$$\left( \frac{\text{current measurement count}}{65,535} \right) \times \text{full stroke range}$$

Sample Conversion:

If the full stroke range is **30 inches** and the current position is **0x0FF2** (4082 Decimal) then,

$$\left( \frac{4082}{65,535} \right) \times 30.00 \text{ inches} = 1.87 \text{ inches}$$

If the full stroke range is **625 mm** and the current position is **0x0FF2** (4082 Decimal) then,

$$\left( \frac{4082}{65,535} \right) \times 625 \text{ mm} = 39 \text{ mm}$$



### Current % of Measurement Range

The **Current % of Measurement Range** is a 2-byte value that expresses the current linear position as a percentage of the entire full stroke range. Resolution is **.1 %** of the full stroke measurement range.

This value starts at **0x0000** at the beginning of the stroke and ends at **0x03E8**.

Example:

Hex	Decimal	Percent
0000	0000	0.0%
0001	0001	0.1%
0002	0002	0.2%
...	...	...
03E8	1000	100.0%

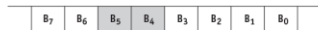

### Error Flags

**0x55** (yellow LED on controller board) indicates that the sensor has begun to travel beyond the calibrated range of the internal position potentiometer.

**0xAA** (red LED on controller board) indicates that the sensor has moved well beyond the calibrated range of the internal position potentiometer.

If either error flag occurs within the full stroke range of the sensor, the unit should be returned to the factory for repair and recalibration.

### Velocity

Data in bytes **B<sub>7</sub>** - **B<sub>6</sub>** is the change in the **CMC** (current measurement count) over a 100 msec time period. This data can then be used to calculate velocity in a post processing operation.

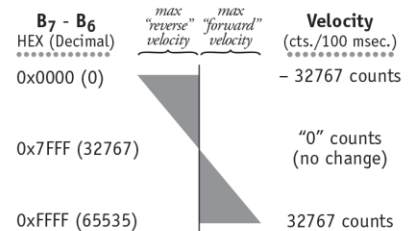

### Velocity Calculation

$$\left( \frac{\text{count change} - 32767}{.1 \text{ sec. time period}} \right) \times \left( \frac{\text{full stroke range}}{65,535} \right)$$

#### Sample Calculations

Cable Extension (positive direction):

**B<sub>7</sub>-B<sub>6</sub> = 0x89C6** (43462 Dec), **full stroke = 60 in.**

$$\left( \frac{35270 - 32767}{.1 \text{ sec}} \right) \times \left( \frac{60 \text{ in.}}{65,535} \right) = 22.92 \text{ in. / sec.}$$

Cable Retraction (negative direction):

**B<sub>7</sub>-B<sub>6</sub> = 0x61A8** (25000 Dec), **full stroke = 60 in.**

$$\left( \frac{25000 - 32767}{.1 \text{ sec}} \right) \times \left( \frac{60 \text{ in.}}{65,535} \right) = -71.11 \text{ in. / sec.}$$

### Setting the Address (Node ID) and Baud Rate

#### Address Setting (Node ID)

The Address Setting (Node ID) is set via 6 switches located on the 8-pole DIP switch found on the DeviceNET controller board located inside the transducer.

The DIP switch settings are binary starting with switch number 1 (= 2<sup>0</sup>) and ending with switch number 6 (= 2<sup>5</sup>).

DIP-1 (2 <sup>0</sup> )	DIP-2 (2 <sup>1</sup> )	DIP-3 (2 <sup>2</sup> )	DIP-4 (2 <sup>3</sup> )	DIP-5 (2 <sup>4</sup> )	DIP-6 (2 <sup>5</sup> )	address (decimal)
0	0	0	0	0	0	0
1	0	0	0	0	0	1
0	1	0	0	0	0	2
...	...	...	...	...	...	...
1	1	1	1	1	1	63

#### Baud Rate

The transmission baud rate may be either factory preset at the time of order or set manually at the time of installation.

The baud rate can be set using switches 7 & 8 on the 8-pole DIP switch found on the DeviceNET controller board located inside the transducer.

DIP-7	DIP-8	baud rate
0	0	125k
1	0	250k
0	1	500k
1	1	125k



#### CANBus Controller Board

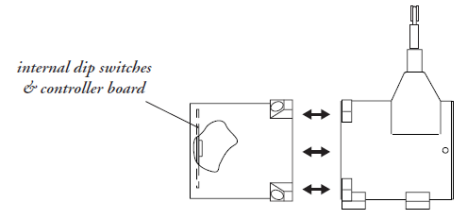
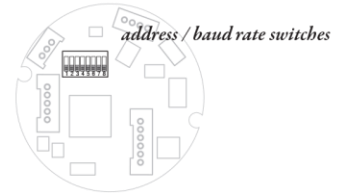

to gain access to the controller board, remove four Allen-Head Screws and remove rear cover.

### Outline Drawing

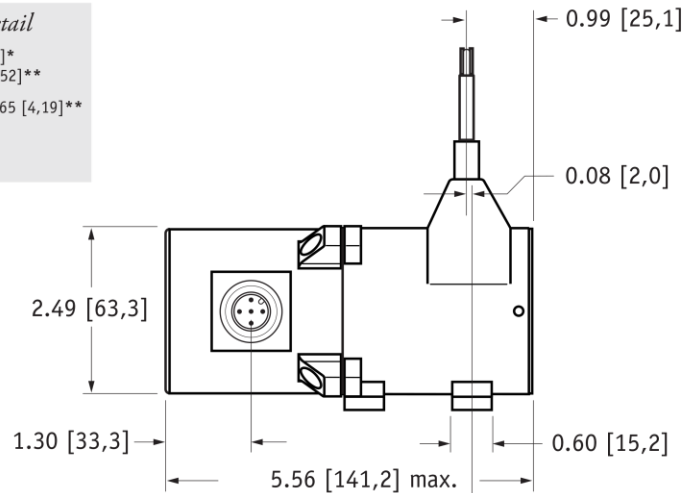
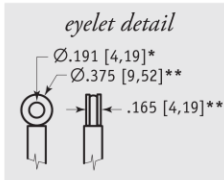
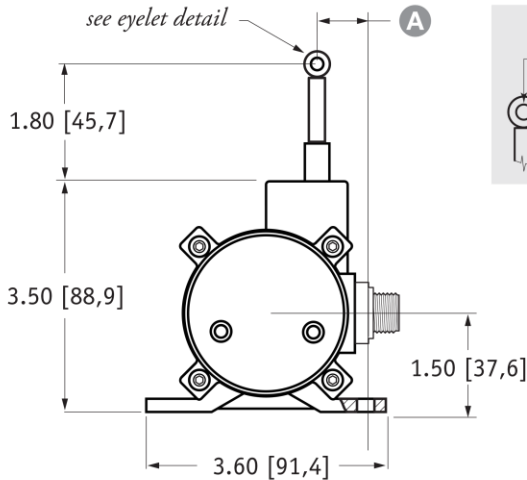

RANGE	A
2", 10"	1.16 [29,5]
5", 25", 50"	0.66 [16,8]
15"	0.99 [25,7]
20", 40"	0.85 [21,6]
30", 60"	0.52 [13,3]

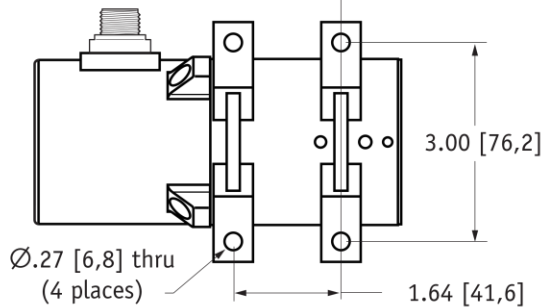

DIMENSIONS ARE IN INCHES [MM]  
 tolerances are ±0.02 in. [±0,5 mm] unless otherwise noted  
 note: \*tolerance = +.005 - .001 [+13 - .03]    \*\*tolerance = +.005 - .005 [+13 - .13]

### Ordering Information

#### Model Number:

**PT8CN** - **R** - **A** - **B** - **C** - **D** - **J** - **F** - **G** - **H**

*order code:*

Sample Model Number:

**PT8CN - 50ALN34T1CG - J50032SC5**

- R** range: 50 (50 inches)
- A** enclosure: AL (aluminum)
- B** measuring cable: N34 (.034 nylon-coated stainless)
- C** measuring cable tension: T1 (standard)
- D** cable guide: CG (standard)
- F** interface: J (CANbus SAE J1939)
- F** baud rate: 500 (500k bits/sec.)
- G** node ID: 32 (32 decimal)
- H** electrical connection: SC5 (5-meter cordset with straight plug)

#### Full Stroke Range:

<b>R</b> order code:	2	5	10	15	20	25	30	40	50	60
full stroke range, min:	2 in.	5 in.	10 in.	15 in.	20 in.	25 in.	30 in.	40 in.	50	60
accuracy (% of f.s.):	1.00%	1.00%	0.15%	0.15%	0.15%	0.15%	0.15%	0.10%	0.10%	0.10%
potentiometer cycle life*:	2.5 x 10 <sup>6</sup>	2.5 x 10 <sup>6</sup>	5 x 10 <sup>5</sup>	5 x 10 <sup>5</sup>	5 x 10 <sup>5</sup>	5 x 10 <sup>5</sup>	5 x 10 <sup>5</sup>	2.5 x 10 <sup>5</sup>	2.5 x 10 <sup>5</sup>	2.5 x 10 <sup>5</sup>

\*-1 cycle is defined as the travel of the measuring cable from full retraction to full extension and back to full retraction

#### Enclosure Material:

<b>A</b> order code:	AL	SS	316
	powder-painted aluminum	303 stainless steel	316 stainless steel

#### Measuring Cable:

<b>B</b> order code:	N34	S47	S31	V62
cable construction:	Ø.034-inch nylon-coated stainless steel rope	Ø.047-inch bare stainless steel rope	Ø.031-inch bare stainless steel rope	Ø.058-inch PVC jacketed vectra fiber rope
available ranges:	<i>all ranges</i>	<i>5, 15, 20, 25, 30-inch only</i>	<i>40, 50, 60-inch only</i>	<i>thru 30 inches only</i>
general use:	indoor	outdoor, debris, high temperature	outdoor, debris, high temperature	high voltage or magnetic field

#### Measuring Cable Tension:

<b>C</b> order code:	T1	T2	T3
	standard tension	medium tension	high tension
full stroke range cable tension specifications	2, 10-inch:	39 oz.	116 oz.
	15-inch:	26 oz.	77 oz.
	20, 40-inch:	20 oz.	60 oz.
	5, 25, 50-inch:	16 oz.	47 oz.
	30, 60-inch:	13 oz.	22 oz.

tension tolerance: ± 50%

	maximum acceleration	maximum acceleration	maximum acceleration
aluminum enclosure:	15 g	25 g	40 g
stainless steel enclosure:	6 g	12 g	18 g

#### Cable Guide:

<b>D</b> order code:	CG	SS	CB*	BR
	standard cable guide	stainless steel cable guide	polyurethane cable guide	integral cable brush

\*note: all ranges up to 25 inches only

# PT8CN

CANbus • SAE J1939 Output Signal



## Baud Rate:

<b>f</b> order code:	<b>125</b>	<b>250</b>	<b>500</b>
	125 kbaud	250 kbaud	500 kbaud

## Node ID:

<b>G</b> order code:	<b>0</b>	<b>1</b>	<b>2</b>	<b>...</b>	<b>62</b>	<b>63</b>
	select address (0 - 63 Decimal)					

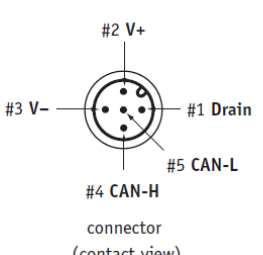
## Electrical Connection:

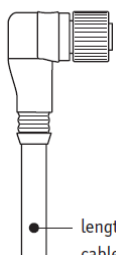
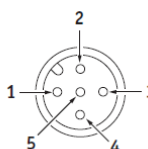
<b>H</b> order code:	<b>blank</b>	<b>MC5</b>	<b>SC5</b>	<b>NC5</b>																		
	5-pin micro-connector (no mating plug supplied)	5-pin micro-connector w/ mating plug	5-pin micro-connector and 5 meter length cordset w/straight mating plug	5-pin micro-connector and 5 meter length cordset w/90° mating plug																		
	 <p>connector (contact view)</p>	 <p>0.16" - 0.32" OD Cable (THIN)</p>	 <p>length: 16ft [5M] cable: Thin</p>	 <p>length: 16ft [5M] cable: Thin</p>																		
		 <p>mating plug (contact view)</p>	<table border="1"> <thead> <tr> <th>pin</th> <th>signal</th> <th>wire color</th> </tr> </thead> <tbody> <tr> <td>1</td> <td>drain</td> <td>brown</td> </tr> <tr> <td>2</td> <td>V+</td> <td>white</td> </tr> <tr> <td>3</td> <td>V-</td> <td>blue</td> </tr> <tr> <td>4</td> <td>Can-H</td> <td>black</td> </tr> <tr> <td>5</td> <td>Can-L</td> <td>grey</td> </tr> </tbody> </table>	pin	signal	wire color	1	drain	brown	2	V+	white	3	V-	blue	4	Can-H	black	5	Can-L	grey	
pin	signal	wire color																				
1	drain	brown																				
2	V+	white																				
3	V-	blue																				
4	Can-H	black																				
5	Can-L	grey																				

Measurement Specialties, Inc., a TE Connectivity company.

Measurement Specialties, TE Connectivity, TE Connectivity (logo) and EVERY CONNECTION COUNTS are trademarks. All other logos, products and/or company names referred to herein might be trademarks of their respective owners.

The information given herein, including drawings, illustrations and schematics which are intended for illustration purposes only, is believed to be reliable. However, TE Connectivity makes no warranties as to its accuracy or completeness and disclaims any liability in connection with its use. TE Connectivity's obligations shall only be as set forth in TE Connectivity's Standard Terms and Conditions of Sale for this product and in no case will TE Connectivity be liable for any incidental, indirect or consequential damages arising out of the sale, resale, use or misuse of the product. Users of TE Connectivity products should make their own evaluation to determine the suitability of each such product for the specific application.

© 2015 TE Connectivity Ltd. family of companies All Rights Reserved.

PT8CN 12/01/2015