

The PT8232 delivers position feedback via RS232 serial communication to your data acquisition or controller system. The PT8232 sends a raw 16-bit count from 0000H to FFFFH. Additionally this device can be set to continuously send data or send data only when polled.

As the internal position sensing element is a precision potentiometer, this transducer maintains current accurate position even during power loss and does not need to be reset to a "home" position.

PT8232

Cable Actuated Sensor Industrial • RS232

Absolute Linear Position to 60 inches (1524 mm)

Aluminum or Stainless Steel Enclosure Options

VLS Option to Prevent Free-Release Damage

IP68 / NEMA 6

GENERAL

Full Stroke Ranges	0-2 to 0-60 inches
Electrical Interface Format	RS232 HEX
Accuracy	see ordering information
Repeatability	± 0.02% full stroke
Resolution	± 0.003% full stroke
Measuring Cable	stainless steel or thermoplastic
Enclosure Material	powder-painted aluminum or stainless steel
Sensor	plastic-hybrid precision potentiometer
Potentiometer Cycle Life	see ordering information
Max. Retraction Acceleration	see ordering information

ELECTRICAL

Input Voltage	9...22 VDC
Input Current	40 mA
Baud Rate	9600 (selectable to 38.4K)
Update Rate	32 msec

ENVIRONMENTAL

Environmental Suitability	NEMA 4X/6, IP 67
Operating Temperature	-40° to 200°F (-40° to 90°C)
Vibration	up to 10 g's to 2000 Hz maximum
Weight, Aluminum Enclosure	3 lbs. max.
Weight, Stainless Steel Encl.	6 lbs. max.

Output Signal

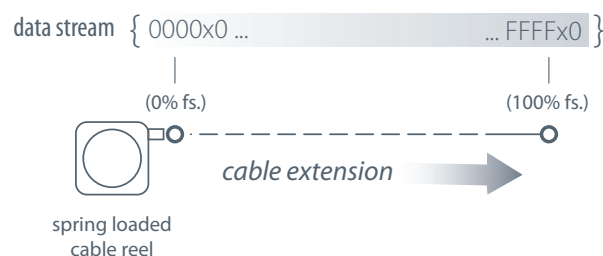

I/O Format:

Data Format

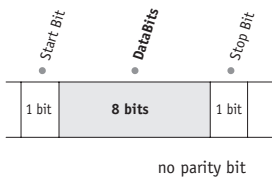

Data Frame

6 byte Hex string:

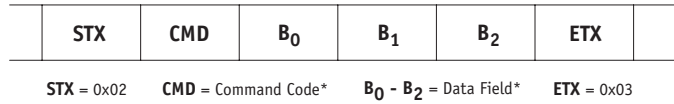

*-see below

Important! All communications to/from the transducer are in HEX!

User Commands:

Description	User Command				Sensor Response			
	<CMD>	<B ₀ >	<B ₁ >	<B ₂ >	<CMD>	<B ₀ >	<B ₁ >	<B ₂ >
Get Sensor Info	0x05	0x00	0x00	0x00	0x05	version ⁽⁴⁾	date ⁽⁵⁾	date ⁽⁵⁾
Get Serial Number	0x15	0x00	0x00	0x00	0x15	serial number ⁽³⁾		
Start Continuous Data	0x25	0x00	0x00	0x00	0x25	0x00	0x00	0x00
Stop Continuous Data	0x35	0x00	0x00	0x00	0x35	0x00	0x00	0x00
Get Position Data	0x45	0x00	0x00	0x00	0x45	CMC ⁽¹⁾	CMC ⁽¹⁾	status ⁽²⁾

(1) CMC - Current Measurement Count (Position)

The Current Measurement Count (CMC) is the output data that indicates the present position of the measuring cable.

The CMC is a 16-bit value that occupies the first two bytes (B₀ and B₁) of the data field. B₀ is the MSB (most significant byte) and B₁ is the LSB (least significant byte).

The CMC starts at 0000H with the measuring cable fully retracted and continues upward to the end of the stroke range stopping at FFFFH. This holds true for all ranges.

(2) Status

The status byte is used as a flag to indicate the validity of the position signal that the internal electronics receives from the potentiometer.

Flags are as follows:
0x00 = GREEN, 0x55 = YELLOW, 0xAA = RED

A "green" flag shows everything OK. A "yellow" or "red" flag indicates that the sensor has either been extended beyond its range or that there is a problem with the potentiometer.

(5) Date

This is a 2 byte value showing the date of currently installed firmware. This value ranges from 01011 - 12319 (decimal). Format is MMDDY. While the month and day are expressed as two digit numbers the year is expressed in a single digit only.

Example: 08054 = August 5, 2004

(3) Serial Number

Each sensor has its own unique serial number. This information can be retrieved by sending the sensor the "Get Serial Number" command.

The serial number is a 3 byte value from which ranges from 0 to 9999999 (decimal).

(4) Version

This is a single byte value (0-255 decimal) which indicates the currently installed firmware version of the sensor.

Baud Rate

The baud rate can be set using switches 7 & 8 on the 8-pole DIP switch found on the rs232 controller board located inside the transducer.

DIP-7	DIP-8	baud rate
0	0	9600
1	0	19200
0	1	38400
1	1	9600



RS232 Controller Board and DIP Switch Location

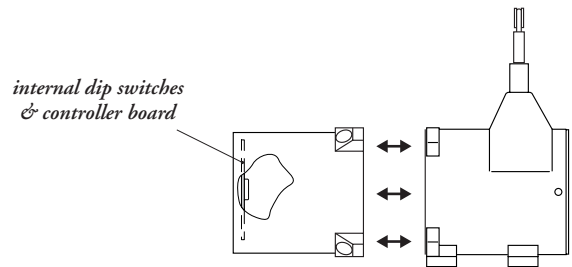
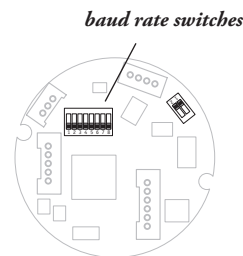

to gain access to the controller board, remove four Allen-Head Screws and remove rear cover.

Outline Drawing:

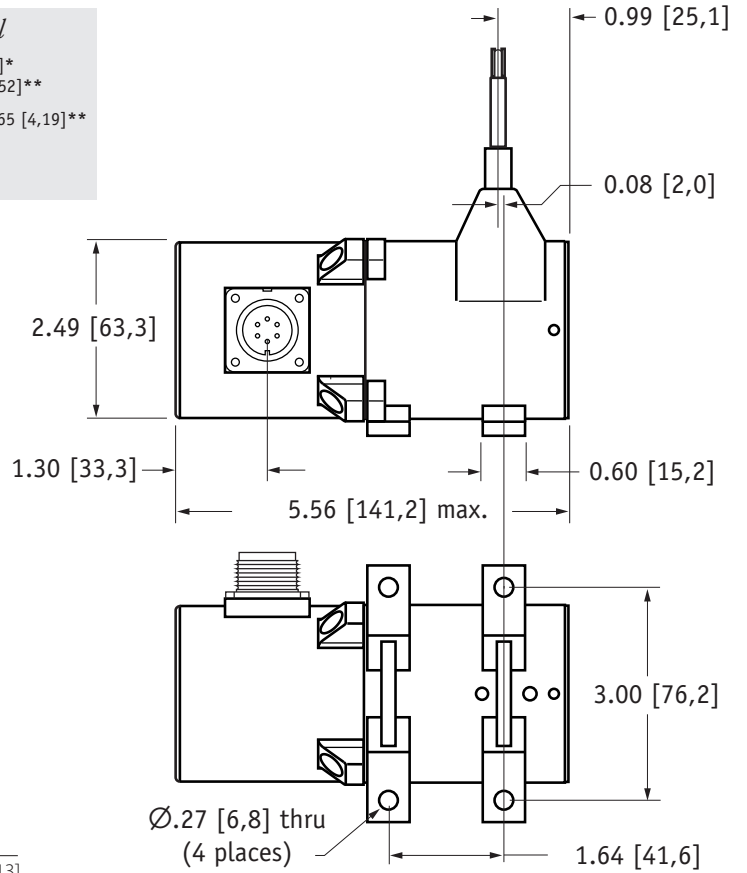
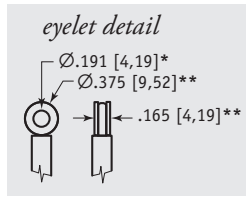
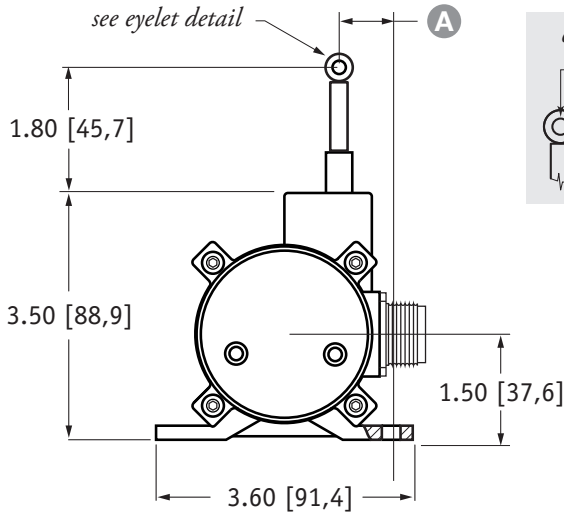

RANGE		A
2", 10"	1.16 [29,5]	
5", 25", 50"	0.66 [16,8]	
15"	0.99 [25,7]	
20", 40"	0.85 [21,6]	
30", 60"	0.52 [13,3]	

DIMENSIONS ARE IN INCHES [MM]
 tolerances are ±0.02 in. [±0,5 mm] unless otherwise noted
 note: *tolerance = +.005 -0.001 [+13 -03] **tolerance = +.005 -0.005 [+13 -13]

Ordering Information:

Model Number:



Sample Model Number:

PT8232 - 50 - AL - N34 - T1 - CG - M6

- R** range: 200 inches
- A** enclosure: aluminum
- B** measuring cable: .034 nylon-coated stainless
- C** measuring cable tension: standard
- D** cable guide: standard
- E** electrical connection: 6-pin plastic connector

Full Stroke Range:

R order code:	2	5	10	15	20	25	30	40	50	60
full stroke range, min:	2 in.	5 in.	10 in.	15 in.	20 in.	25 in.	30 in.	40 in.	50	60
accuracy (% of f.s.):	1.00%	1.00%	0.15%	0.15%	0.15%	0.15%	0.15%	0.10%	0.10%	0.10%
potentiometer cycle life*:	2.5 x 10 ⁶	2.5 x 10 ⁶	5 x 10 ⁵	5 x 10 ⁵	5 x 10 ⁵	5 x 10 ⁵	5 x 10 ⁵	2.5 x 10 ⁵	2.5 x 10 ⁵	2.5 x 10 ⁵

*-1 cycle is defined as the travel of the measuring cable from full retraction to full extension and back to full retraction

Enclosure Material:

A order code:	AL	SS	316
	powder-painted aluminum	303 stainless steel	316 stainless steel

Ordering Information (cont.):

Measuring Cable:

B order code:	N34	S47	S31	V62
cable construction:	Ø.034-inch nylon-coated stainless steel rope	Ø.047-inch bare stainless steel rope	Ø.031-inch bare stainless steel rope	Ø.058-inch PVC jacketed vectra fiber rope
available ranges:	<i>all ranges</i>	<i>5, 15, 20, 25, 30-inch only</i>	<i>40, 50, 60-inch only</i>	<i>thru 30 inches only</i>
general use:	indoor	outdoor, debris, high temperature	outdoor, debris, high temperature	high voltage or magnetic field

Measuring Cable Tension:

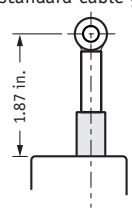
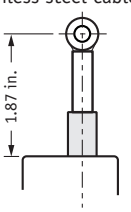
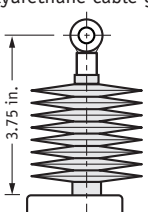
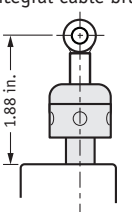

C order code:	T1	T2	T3
	standard tension	medium tension	high tension
<i>full stroke range cable tension specifications</i>	2, 10-inch:	39 oz.	116 oz.
	15-inch:	26 oz.	77 oz.
	20, 40-inch:	20 oz.	60 oz.
	5, 25, 50-inch:	16 oz.	47 oz.
	30, 60-inch:	13 oz.	22 oz.
	tension tolerance: ± 50%		
	<i>maximum acceleration</i>	<i>maximum acceleration</i>	<i>maximum acceleration</i>
aluminum enclosure:	15 g	25 g	40 g
stainless steel enclosure:	6 g	12 g	18 g

Cable Guide Options:

D order code:	CG	SS	CB*	BR
	standard cable guide	stainless steel cable guide	polyurethane cable guide	integral cable brush
				

*note: all ranges up to 25 inches only

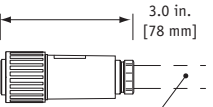
Electrical Connection:

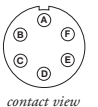
E order code:	M6	C25																												
	6-pin plastic connector with mating plug IP 67, NEMA 6, NEMA 4X (stainless enclosure only)	25-ft. instrumentation cable 24 AWG, shielded IP 67, NEMA 6																												
																														
	.30 - .39 in. [8 - 10 mm] cable dia. 16 AWG max conductor size connector: MS3102E-14S-6P mating plug: MS3106E-14S-6S																													
	 <table border="0"> <tr> <td>pin</td> <td>signal</td> </tr> <tr> <td>A</td> <td>9...22 VDC common</td> </tr> <tr> <td>B</td> <td>-</td> </tr> <tr> <td>C</td> <td>Transmitted Data</td> </tr> <tr> <td>D</td> <td>Received Data</td> </tr> <tr> <td>E</td> <td>common</td> </tr> <tr> <td>F</td> <td>common</td> </tr> </table>	pin	signal	A	9...22 VDC common	B	-	C	Transmitted Data	D	Received Data	E	common	F	common	<table border="0"> <tr> <td>color code</td> <td>signal</td> </tr> <tr> <td>Red</td> <td>9...22 VDC common</td> </tr> <tr> <td>Black</td> <td>-</td> </tr> <tr> <td>White</td> <td>Transmitted Data</td> </tr> <tr> <td>Green</td> <td>Received Data</td> </tr> <tr> <td>Blue</td> <td>common</td> </tr> <tr> <td>Brown</td> <td>common</td> </tr> </table>	color code	signal	Red	9...22 VDC common	Black	-	White	Transmitted Data	Green	Received Data	Blue	common	Brown	common
pin	signal																													
A	9...22 VDC common																													
B	-																													
C	Transmitted Data																													
D	Received Data																													
E	common																													
F	common																													
color code	signal																													
Red	9...22 VDC common																													
Black	-																													
White	Transmitted Data																													
Green	Received Data																													
Blue	common																													
Brown	common																													

VLS Option - Free Release Protection

The patented Celesco Velocity Limiting System (VLS) is an option for PT8000 Series cable extension transducers that limits cable retraction to a safe 40 to 55 inches per second.

The VLS option prevents the measuring cable from ever reaching a damaging velocity during an accidental free release. This option is ideal for mobile applications that require frequent cable disconnection and reconnection. It prevents expensive unscheduled downtime due to accidental cable mishandling or attachment failure.

VLS is NOT available for medium and high cable tension options, stainless steel enclosure, cable bellows or 2, 5 and 15-inch stroke ranges.

How To Configure Model Number for VLS Option:

VLS8232	-	AL	-	T1	-		-	
	Ⓡ	Ⓐ	Ⓟ	Ⓢ	Ⓣ	Ⓝ	Ⓜ	Ⓟ
15		N34		CG		M6		
20		S47		SS		C25		
25		S31		BR				
30		V62						
40								
50								
60								

■ = available options**

creating VLS model number (example):

1. select PT8232 model **PT8232-60-S31-T1-CG-M6**
2. remove "PT" from the model number ~~PT~~ **8232-60-S31-T1-CG-M6**
3. add "VLS" **VLS + 8232-60-S31-T1-CG-M6**
4. completed model number ! **VLS8232-60-S31-T1-CG-M6**

**Note: please contact factory for a solution to options not supported.

NORTH AMERICA
Measurement Specialties, Inc.
a TE Connectivity Company

Tel: +1-800-522-6752

customercare.chtw@te.com

te.com/sensorsolutions

Measurement Specialties Inc. a TE Connectivity company

Measurement Specialties, TE Connectivity, TE Connectivity (logo) and Every Connection Counts are trademarks. All other logos, products and/or company names referred to herein might be trademarks of their respective owners.

The information given herein, including drawings, illustrations and schematics which are intended for illustration purposes only, is believed to be reliable. However, TE Connectivity makes no warranties as to its accuracy or completeness and disclaims any liability in connection with its use. TE Connectivity's obligations shall only be as set forth in TE Connectivity's Standard Terms and Conditions of Sale for this product and in no case will TE Connectivity be liable for any incidental, indirect or consequential damages arising out of the sale, resale, use or misuse of the product. Users of TE Connectivity products should make their own evaluation to determine the suitability of each such product for the specific application.

© 2016 TE Connectivity Ltd. family of companies All Rights Reserved.