

3.3" [83 mm]

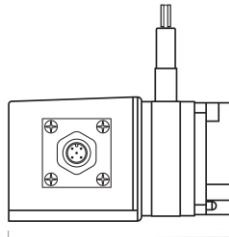

3.9" [98 mm]

The PT1DN communicates to your PLC over DeviceNET® and provides a precision position feedback signal for full-scale measurement ranges from 2 to 50 inches. Because the PT1DN uses a potentiometer as its sensing element, the position signal is “absolute” and does not have to be reset to a “home” position upon startup.

The PT1DN is part of our compact line of cable-extension transducers and is perfect where space is limited.

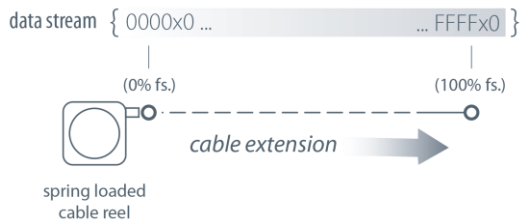

## PT1DN

### Cable Actuated Sensor Industrial Grade DeviceNET® Communication

**Absolute Linear Position to 50 inches (1270 mm)**

**Aluminum and Polycarbonate Enclosure**

**Compact Design**

**IP65 • NEMA 4 Protection**

#### General

<b>Full Stroke Range</b>	0-2 to 0-50 inches
<b>Electrical Interface</b>	CANbus ISO 11898
<b>Protocol</b>	DeviceNET version 2.0
<b>Accuracy</b>	± 0.25% to ± 0.10% full stroke (see ordering information)
<b>Repeatability</b>	± 0.02% full stroke
<b>Resolution</b>	± 0.003% full stroke
<b>Measuring Cable</b>	.019-in. dia. nylon-coated stainless steel
<b>Enclosure</b>	glass-filled polycarbonate and black anodized aluminum
<b>Sensor</b>	plastic-hybrid precision potentiometer
<b>Potentiometer Cycle Life</b>	see ordering information
<b>Maximum Retraction</b>	see ordering information
<b>Acceleration</b>	
<b>Weight</b>	1 lb. max.

#### Electrical

<b>Input Voltage</b>	bus powered
<b>Input Current</b>	40 mA
<b>Address Setting/Node ID</b>	0...63 set via DIP switches (default setting: 63)
<b>Baud Rate</b>	125K, 250K or 500K set via DIP switches
<b>EDS File</b>	available @ <a href="http://www.celeso.com/download">http://www.celeso.com/download</a>

#### Environmental

<b>Environmental Suitability</b>	NEMA 4, IP 67
<b>Operating Temperature</b>	0° to 185°F (-17° to 85°C)
<b>Vibration</b>	up to 10 g to 2000 Hz maximum

I/O Format

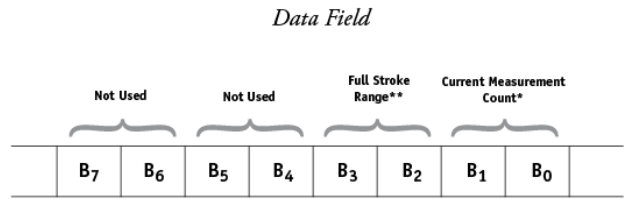
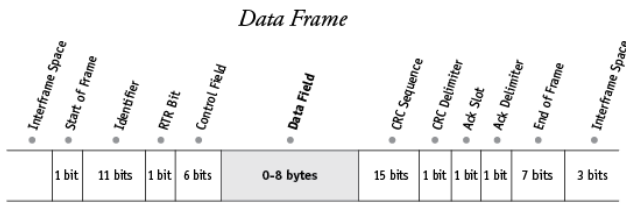

**\*Current Measurement Count**

The Current Measurement Count (CMC) is the output data that indicates the present position of the measuring cable.

The CMC is a 16-bit value that occupies the first two bytes (B<sub>0</sub> and B<sub>1</sub>) of the data field. B<sub>0</sub> is the LSB (least significant byte) and B<sub>1</sub> is the MSB (most significant byte).

The CMC starts at 0000H with the measuring cable fully retracted and continues upward to the end of the stroke range stopping at FFFFH. This holds true for all ranges.

**\*\*Full Stroke Range**

The Full Stroke Range (FSR) is a 16-bit value in the data field that expresses the full range of the sensor in inches. This value can be used to convert the actual count to units of measurement should the application require it.

The full stroke measurement range occupies the second two bytes (B<sub>2</sub> and B<sub>3</sub>) of the data field.

B<sub>2</sub> is the LSB (least significant byte) and B<sub>3</sub> is the MSB (most significant byte).

This value is expressed in inches.

Example:

Hex Value	Decimal Equivalent	Full Stroke Range
001E	30	30 inches

**Converting CMC to Inches**

If required, the CMC can easily be converted to a linear measurement expressed in inches instead of just counts.

This is accomplished by first dividing the CMC by 65,535 (total counts over the range) and then multiplying that value by the FSR:

$$\left( \frac{\text{CMC}}{65,535} \right) \times \text{FSR}$$

Example:

If the full stroke range is 30 inches and the current position is OFF2 Hex (4082 Decimal) then,

$$\left( \frac{4082}{65,535} \right) \times 30.00 \text{ inches} = 1.87 \text{ inches}$$

**Address Setting (Node ID), Baud Rate and Bus Termination Settings**

**Address Setting (Node ID)**

The Address Setting (Node ID) is set via 6 switches located on the 8-pole DIP switch found on the DeviceNET controller board located inside the transducer.

The DIP switch settings are binary starting with switch number 1 (= 2<sup>0</sup>) and ending with switch number 6 (= 2<sup>5</sup>).

DIP-1 (2 <sup>0</sup> )	DIP-2 (2 <sup>1</sup> )	DIP-3 (2 <sup>2</sup> )	DIP-4 (2 <sup>3</sup> )	DIP-5 (2 <sup>4</sup> )	DIP-6 (2 <sup>5</sup> )	address (decimal)
0	0	0	0	0	0	0
1	0	0	0	0	0	1
0	1	0	0	0	0	2
...	...	...	...	...	...	...
1	1	1	1	1	1	63



**Baud Rate**

The transmission baud rate may be either factory preset at the time of order or set manually at the time of installation.

The baud rate can be set using switches 7 & 8 on the 8-pole DIP switch found on the DeviceNET controller board located inside the transducer.

DIP-7	DIP-8	baud rate
0	0	125k
1	0	250k
0	1	500k
1	1	125k



**Bus Termination**

The setting of the internal bus termination resistor may be specified upon order or manually changed by the end user at the time of installation.

The bus termination resistor is activated setting switches 1 & 2 on the 2-pole DIP switch (located on the internal DeviceNET controller board) to the "ON" position.

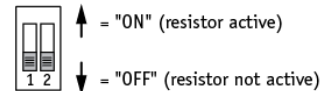

**DeviceNET Controller Board and DIP Switch Location**

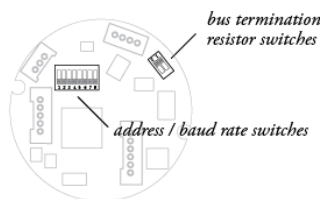

to gain access to the controller board, remove four Allen-Head Screws and remove rear cover.

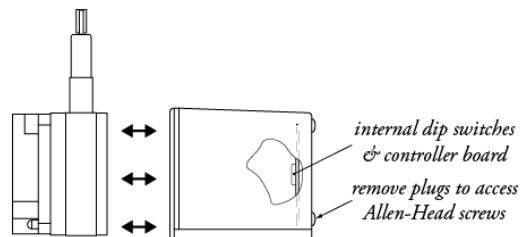

Outline Drawing

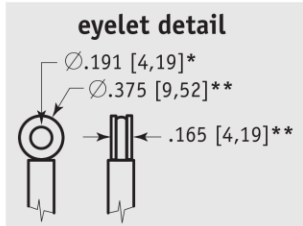

Range	A
2, 10	1.04 [26,4]
5, 25, 50	0.58 [14,7]
15, 30	0.82 [20,8]
20, 40	0.74 [18,8]
<i>inches [mm]</i>	

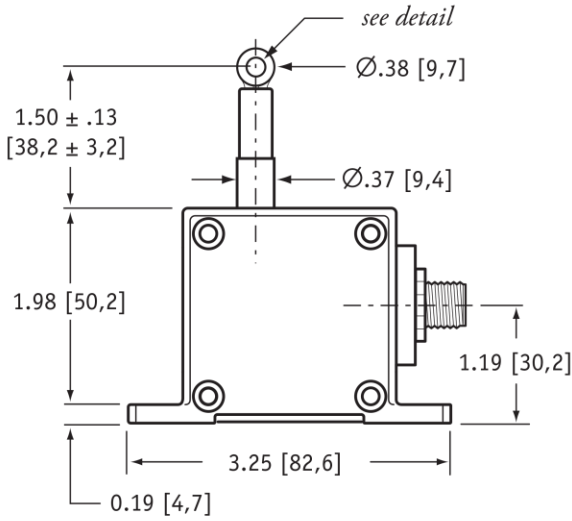

DIMENSIONS ARE IN INCHES [MM]  
tolerances are 0.03 IN. [0.5 MM] unless otherwise noted.

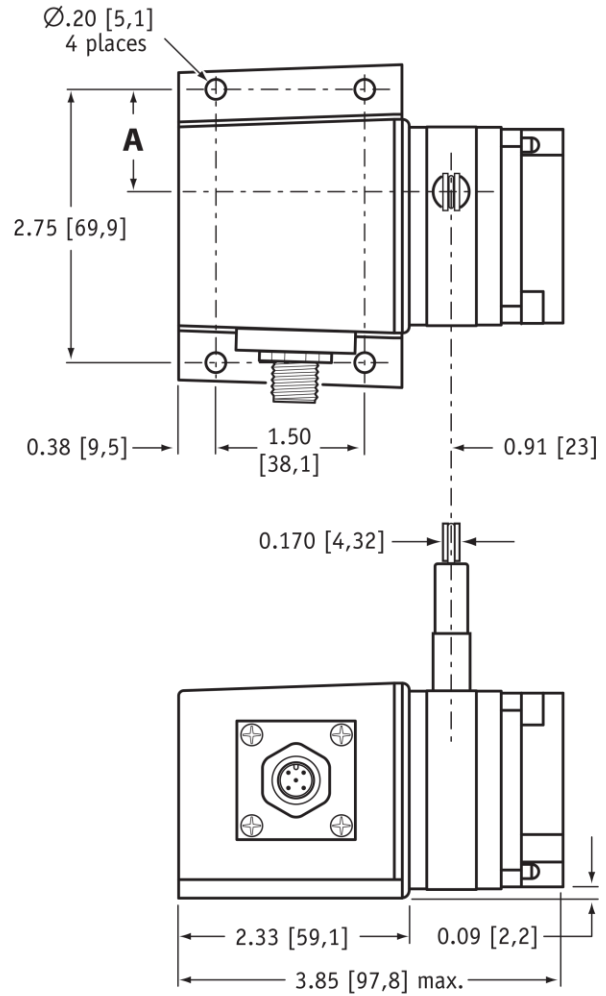

\* tolerance = +.005 -.001 [+.13 -.03]  
\*\* tolerance = +.005 -.005 [+.13 -.13]

Ordering Information

Model Number:

**PT1DN** - \_\_\_\_\_  
order code:            **R**        **A**        **B**        **C**        **D**        **E**

Sample Model Number:

**PT1DN - 30 - UP - SG - 500 - TR - SC5**

- R** range: 30 inches
- A** measuring cable exit: up
- B** cable guide: spring-loaded guide
- C** baud rate: 500 k bits/sec.
- D** terminating resistor: yes
- E** electrical connection: 5 meter cordset with straight plug

Ordering Information (cont.)

**Full Stroke Range:**

order code:	2	5	10	15	20	25	30	40	50
full stroke range, min:	2 in.	5 in.	10 in.	15 in.	20 in.	25 in.	30 in.	40 in.	50 in.
accuracy (% of f.s.):	0.25%			0.15%			0.10%		
potentiometer cycle life:	2,500,000 cycles			500,000 cycles			250,000 cycles		
cable tension (20%):	12 oz.	5 oz.	12 oz.	9 oz.	6 oz.	5 oz.	9 oz.	6 oz.	5 oz.
max. cable acceleration:	11 g	3 g	11 g	5 g	4 g	3 g	5 g	4 g	3 g

**Cable Exit:**

**A** order code: \_\_\_\_\_

direction: **UP** up      **DN** down      **FR** front      **BK** back

measurement range	2	5	10	15	20	25	30	40	50
<b>A</b>	1.04 in. 26,4 mm	0.58 in. 14,7 mm	1.04 in. 26,4 mm	0.82 in. 20,8 mm	0.74 in. 18,8 mm	0.58 in. 14,7 mm	0.82 in. 20,8 mm	0.74 in. 18,8 mm	0.58 in. 14,7 mm
<b>B</b>	0.75 in. 19,1 mm	0.29 in. 6,1 mm	0.75 in. 19,1 mm	0.53 in. 13,5 mm	0.45 in. 11,5 mm	0.29 in. 6,1 mm	0.53 in. 13,5 mm	0.45 in. 11,5 mm	0.29 in. 6,1 mm
<b>C</b>	1.43 in. 36,3 mm	1.89 in. 48,0 mm	1.43 in. 36,3 mm	1.65 in. 41,9 mm	1.73 in. 43,9 mm	1.89 in. 48,0 mm	1.65 in. 41,9 mm	1.73 in. 43,9 mm	1.89 in. 48,0 mm

**Cable Guide:**

**B** order code: \_\_\_\_\_

blank	SG
standard cable guide	spring-loaded guide
	<p><i>cushions impact from accidental free release</i></p>

\*note: start of full stroke range begins at full compression point (except 2-inch and 5-inch ranges).

**Baud Rate:**

order code:	125	250	500
	125 kbaud	250 kbaud	500 kbaud

**Terminating Resistor:**

<b>① order code:</b>	<b>TR</b>	<b>NR</b>
	terminating resistor	no terminating resistor

**Electrical Connection:**

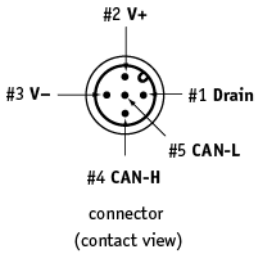
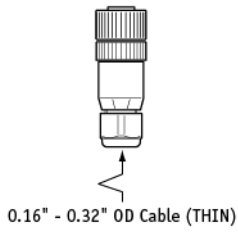
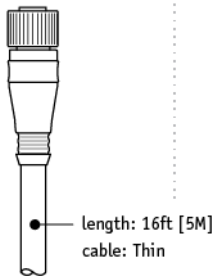
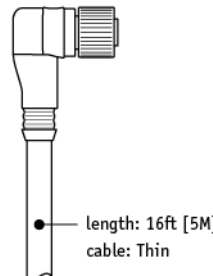
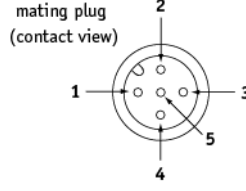
<b>② order code:</b>	<b>blank</b>	<b>MC5</b>	<b>SC5</b>	<b>NC5</b>																		
	5-pin micro-connector <i>(no mating plug supplied)</i>	5-pin micro-connector w/ mating plug	5-pin micro-connector and 5 meter length cordset w/straight mating plug	5-pin micro-connector and 5 meter length cordset w/90° mating plug																		
	 <p>connector (contact view)</p>	 <p>0.16" - 0.32" OD Cable (THIN)</p>	 <p>length: 16ft [5M] cable: Thin</p>	 <p>length: 16ft [5M] cable: Thin</p>																		
		 <p>mating plug (contact view)</p>	<table border="1"> <thead> <tr> <th>pin</th> <th>signal</th> <th>wire color</th> </tr> </thead> <tbody> <tr> <td>1</td> <td>drain</td> <td>brown</td> </tr> <tr> <td>2</td> <td>V+</td> <td>white</td> </tr> <tr> <td>3</td> <td>V-</td> <td>blue</td> </tr> <tr> <td>4</td> <td>Can-H</td> <td>black</td> </tr> <tr> <td>5</td> <td>Can-L</td> <td>grey</td> </tr> </tbody> </table>	pin	signal	wire color	1	drain	brown	2	V+	white	3	V-	blue	4	Can-H	black	5	Can-L	grey	
pin	signal	wire color																				
1	drain	brown																				
2	V+	white																				
3	V-	blue																				
4	Can-H	black																				
5	Can-L	grey																				



**19 Waterman Ave. Toronto, Ont. M4B1Y2**  
**Tel: 416-445-5500 Fax: 416-445-1170**  
**Toll Free: 1-800-465-1600**  
**Email: sales@intertechnology.com**  
**Website: www.intertechnology.com**

[TE.com/sensorsolutions](http://TE.com/sensorsolutions)

Measurement Specialties, Inc., a TE Connectivity company.

Measurement Specialties, TE Connectivity, TE Connectivity (logo) and EVERY CONNECTION COUNTS are trademarks. All other logos, products and/or company names referred to herein might be trademarks of their respective owners.

The information given herein, including drawings, illustrations and schematics which are intended for illustration purposes only, is believed to be reliable. However, TE Connectivity makes no warranties as to its accuracy or completeness and disclaims any liability in connection with its use. TE Connectivity's obligations shall only be as set forth in TE Connectivity's Standard Terms and Conditions of Sale for this product and in no case will TE Connectivity be liable for any incidental, indirect or consequential damages arising out of the sale, resale, use or misuse of the product. Users of TE Connectivity products should make their own evaluation to determine the suitability of each such product for the specific application.

© 2015 TE Connectivity Ltd. family of companies All Rights Reserved.

PT1DN 12/01/2015