



Small-sized, compact and handy joystick for control of industrial machines.  
Juliet is a user-friendly, ergonomic product, suitable for daily use in an industrial environment.

### FEATURES

- Designed to facilitate maintenance, reducing down time and costs: the switches are assembled on pull-out or fixed terminal boards.
- Light and handy: weight 250 grams.
- Mechanical life of switches: 5 million operations.
- IP protection degree: Juliet is classified IP00 or IP65, when housed in Juliet-PK or in a specific enclosure.
- Extreme temperature resistance: -25°C to +70°C.

### OPTIONS

- Available with up to 5 speeds for each direction.
- Stepped or linear operations.
- Cross or 360° movement.
- Available with terminal boards or potentiometers.

### CERTIFICATIONS

- CE marking and EAC certification.

*Fill in the "request form" for accurate product configuration.*

## CERTIFICATIONS

Conformity to Community Directives	2014/35/UE Low Voltage Directive
	2006/42/CE Machinery Directive
Conformity to CE Standards	EN 60204-1 Safety of machinery - Electrical equipment of machines
	EN 60947-1 Low-voltage switchgear and controlgear
	EN 60947-5-1 Low-voltage switchgear and controlgear - Control circuit devices and switching elements - Electromechanical control circuit devices
Marcature e omologazioni	CE ENEC

## GENERAL TECHNICAL SPECIFICATIONS

Ambient temperature	Storage -40°C/+70°C
	Operational -25°C/+70°C
IP protection degree	IP 00 (IP 65 max. when assembled in Juliet-PK or in a specific enclosure)
Operating positions	Any position
Weight	250 g

## TECHNICAL SPECIFICATIONS OF THE SWITCHES

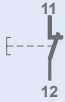
Code	PRVV0804PE
Utilisation category	AC 15
Rated operational current	2 A
Rated operational voltage	48 Vac
Rated thermal current	8 A
Rated insulation voltage	1000 Vac
Mechanical life	5x10 <sup>6</sup> operations
Connections	Screw-type terminals
Wires	0.14 mm <sup>2</sup> - 1.5 mm <sup>2</sup>
Tightening torque	0.22 Nm - 0.25 Nm
Microswitch type	Single break
Contacts	1NC
Scheme	
Markings and homologations	CE

## TECHNICAL SPECIFICATIONS OF THE POTENTIOMETERS

Code	PRVV9021PE	PRVV9026PE
Ohmic value	5 kΩ	10 kΩ
Connections	4 turrets	
Independent linearity (over AEA -3°)	≤ ±1%	
Life time	5x10 <sup>6</sup> movements	
Operational ambient temperature	-55 °C/+125 °C	
Mechanical angle	360° continuous	
Actual Electrical Angle (AEA)	340°±5°	
Ohmic value tolerance	Max ±2% at 20°C	
Dissipation	0.3 W	

# OVERALL DIMENSIONS (mm)

Standard

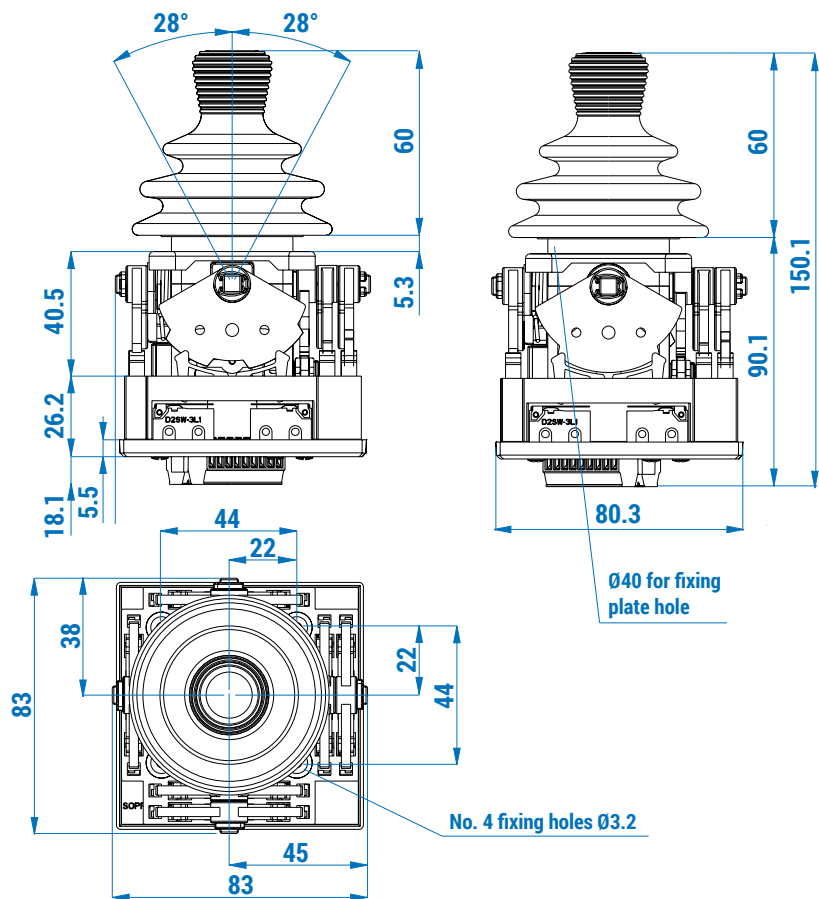

Ø40 for fixing plate hole

No. 4 fixing holes Ø3.2

With potentiometer

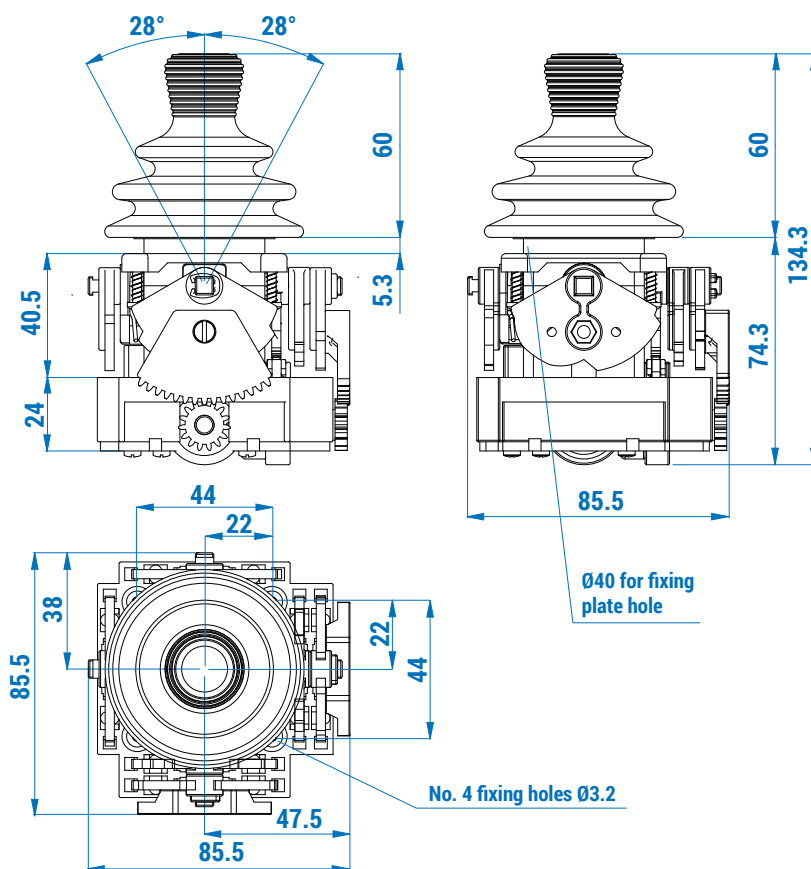

Ø40 for fixing plate hole

No. 4 fixing holes Ø3.2

## STANDARD JOYSTICKS

Juliet standard joysticks feature spring return stepped movement and they are equipped with 1NC switches

PRVV0804PE  and fixed terminal board.

Positions	Direction of movement		Code
	360°	Cross	
1-0		X	PF340210000004
1-1	X		PF340211000001
1-2	X		PF340212000001
1-3		X	PF340213000001
2-0		X	PF340220000004
2-2	X		PF340222000001
2-3	X		PF340223000001
3-0		X	PF340230000004
3-3	X		PF340233000001
3-3		X	PF340233000004
4-0		X	PF340240000004
1-5	X		PF340215000001
3-5	X		PF340235000001
5-5	X		PF340255000001
5-5		X	PF340255000004

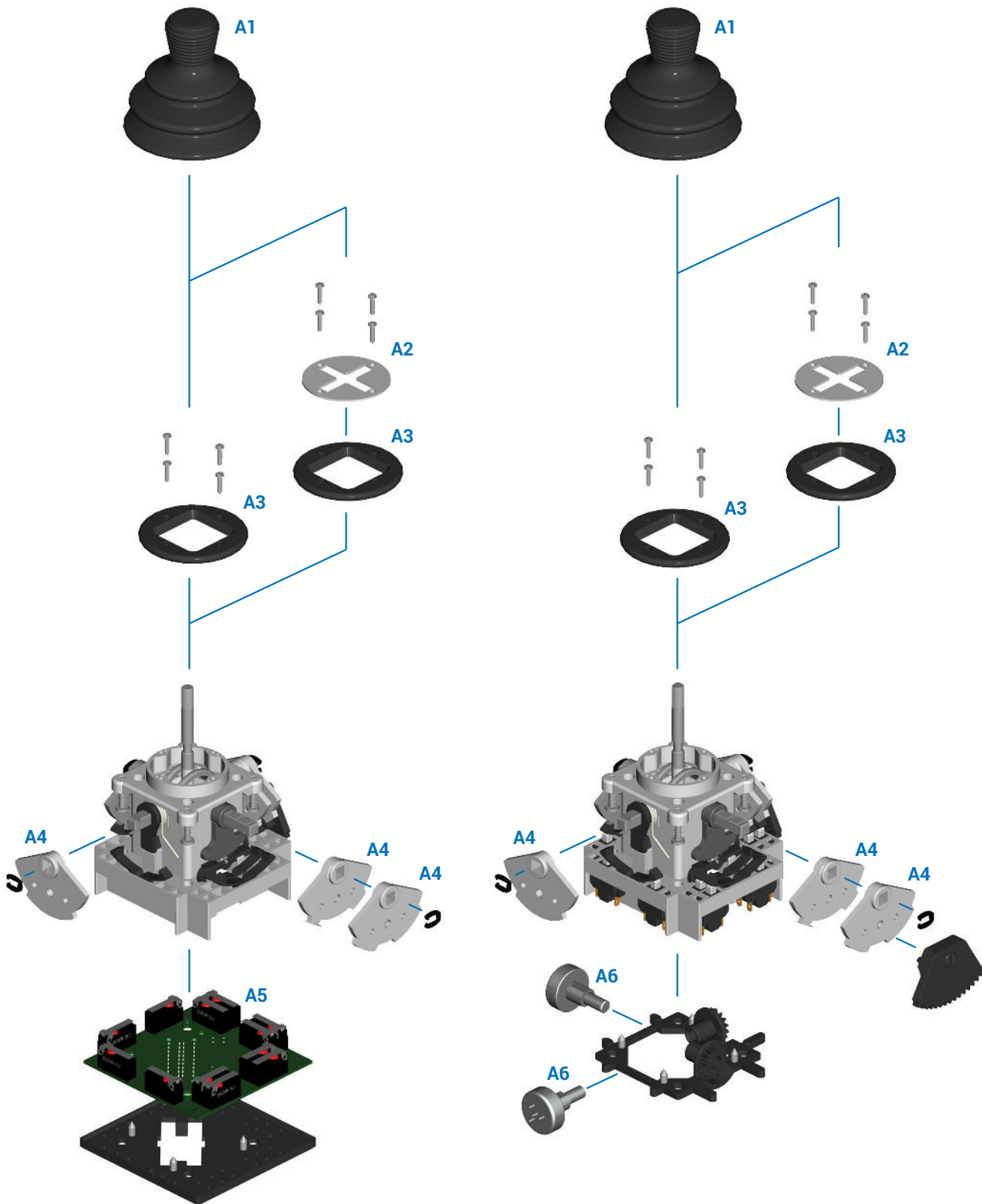

Refer to the following tables for descriptions of components: "Switch boards", "Potentiometers", "Lever guides", "Cams" and "Accessories".

## COMPONENTS

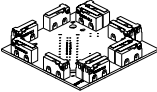

### Switch boards

Ref.	Drawing	Description	Code
A5		12 switch board with fixed terminal board - 5 positions	93547
		8 switch board with fixed terminal board - 3 positions	93558

### Potentiometers

Ref.	Drawing	Description	Code
A6		Potentiometer 5 kΩ	PRVV9021PE
		Potentiometer 10 kΩ	PRVV9026PE

### Lever guides

Ref.	Drawing	Description	Code
A2		Cross lever guide	PRTR0160PE
		Lever guide 3-0	PRSL9824PI
		Lever guide 5-4	PRSL9825PI
		Lever guide 3-3	PRSL9826PI
		Lever guide 5-2	PRSL9828PI
		Lever guide 5-5	PRSL9830PI
		Lever guide 5-0	PRSL9834PI
		Lever guide 4-0	PRSL9835PI
		Lever guide 1-3	PRSL9838PI
		Lever guide 1-5	PRSL9839PI
A3		Lever guide 3-2	PRSL9841PI
		Lever guide 3-5	PRSL9842PI
		Lever guide 2-4	PRSL9843PI
		Lever guide 4-1	PRSL9844PI
		Lever guide 3-4	PRSL9845PI
		Lever guide 4-4	PRSL9849PI
		Lever guide 1-1	PRSL9871PI
		Lever guide 1-0	PRSL9872PI
		Lever guide 1-2	PRSL9873PI
		Lever guide 2-2	PRSL9876PI
	Lever guide 2-0	PRSL9880PI	

## Cams

Ref.	Drawing	Description	Code
A4		Cam 1 <sup>st</sup> step	PRSL7300PI
		Cam 2 <sup>nd</sup> -3 <sup>rd</sup> steps	PRSL7301PI
		Cam 4 <sup>th</sup> -5 <sup>th</sup> steps	PRSL7302PI

## Accessories

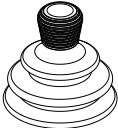
Ref.	Drawing	Description	Code
A1		Bellows	PRSL0173PI

# JULIET - REQUEST FORM FOR NON STANDARD JOYSTICK

## Movement

Stepped

Linear

## Lever guide

Number of steps in each direction

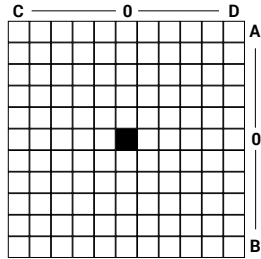

### Examples

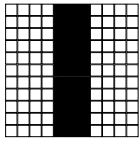

5 steps direction A-B  
1 step direction C-D  
360° movement

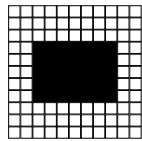

2 steps direction A-B  
3 steps direction C-D  
360° movement

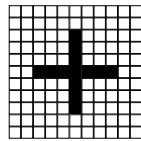

3 steps direction A-B  
3 steps direction C-D  
Cross movement

## Joystick with terminal board

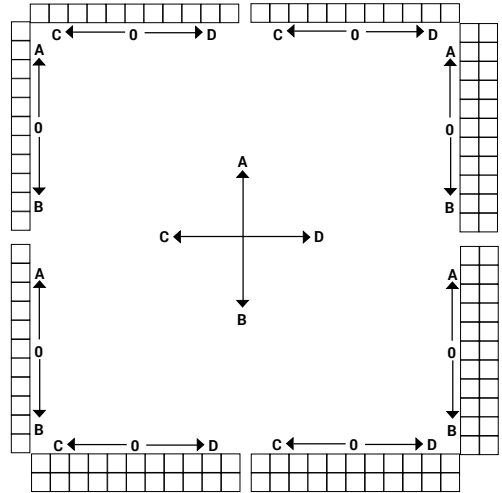

## Joystick with potentiometers

### Potentiometers

1 5 kΩ

2 10 kΩ

3 Pre-set only

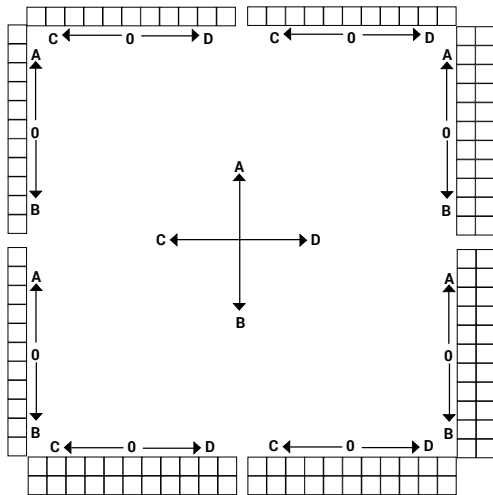

Potentiometer

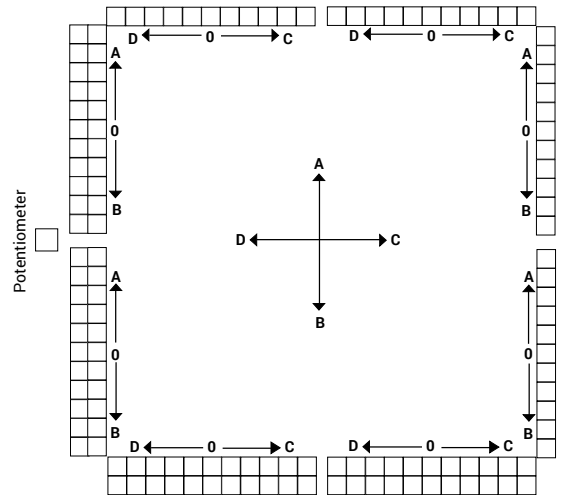

Potentiometer

## Instructions

- Tick the box corresponding to the type of movement required.
- Choose the type of lever guide required blackening the boxes corresponding to the number of steps of the lever in each direction.
- In case of potentiometers, write the number corresponding to the potentiometer.
- Fill in the contact scheme blackening the boxes corresponding to the positions where the cams close the contacts (each bar of 11 boxes corresponds to a switch; the central box corresponds to the zero position of the joystick). In the example, the contact is closed in positions 1-2-3 to the left and 3-4 to the right.

