

CHARLIE

Pendant control station



Compact-sized pendant station for auxiliary control. Modern user-friendly design, developed by an industrial design firm on technical, anthropomorphic, futuristic and ergonomic specifications. Easy to handle and designed to reduce installation time and costs and maintenance down time.

FEATURES

- Reduced time and costs for installation and wiring: the switches are assembled inside the pendant station without screws, with all the terminals facing the cable inlet and screws in the opposite direction to facilitate wiring.
- A threaded ring is used to secure the enclosure and cover, providing easy access to the internal components without any need for tools or screws.
- Thanks to the hollow handle the control station can be quickly and easily set down onto a pin.
- The emergency stop mushroom pushbutton complies with standard EN 418.
- Mechanical life of switches: 1 million operations.
- IP protection degree: Charlie is classified IP65.
- Extreme temperature resistance: -25°C to +70°C.
- All materials and components used are wear resistant and guarantee protection of the unit against water and dust.

OPTIONS

- Available in configuration with 2 or 3 actuators.
- Single switches with NO or NC contacts and double switches with NO contacts, one or two speeds, with electrical interlock to prevent simultaneous operation of opposite functions.

CERTIFICATIONS

- CE marking and EAC certification.

Fill in the "request form" for accurate product configuration.

CERTIFICATIONS

Conformity to Community Directives	2014/35/UE Low Voltage Directive
	2006/42/CE Machinery Directive
Conformity to CE Standards	EN 60204-1 Safety of machinery - Electrical equipment of machines
	EN 60947-1 Low-voltage switchgear and controlgear
	EN 60947-5-1 Low-voltage switchgear and controlgear - Control circuit devices and switching elements - Electromechanical control circuit devices
	EN 60529 Degrees of protection provided by enclosures
	EN 418 Safety of machinery - Emergency stop equipment, functional
Markings and homologations	CE EAC

GENERAL TECHNICAL SPECIFICATIONS

Ambient temperature	Storage -40°C/+70°C
	Operational -25°C/+70°C
IP protection degree	IP 65
Insulation category	Class II
Cable entry	Cable clamp M20
	Spiral cable clamp M20
Operating positions	Any position
Weight	~ 320 g

TECHNICAL SPECIFICATIONS OF THE SWITCHES

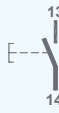
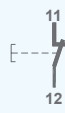
Code	PRSL1000PI	PRSL1001PI
Utilisation category	AC 15	
Rated operational current	3 A	
Rated operational voltage	250 Vac	
Rated thermal current	10 A	
Rated insulation voltage	500 Vac	
Mechanical life	1x10 ⁶ operations	
Connections	Screw-type terminals	
Wires	1x2.5 mm ² , 2x1.5 mm ² (UL - (c)UL: use 60°C or 75°C copper (CU) conductor and wire 16-18 AWG)	
Tightening torque	0.6 Nm	
Microswitch type	Double break, slow action	Double break, slow action
Contacts	1NO	1NC
Scheme		
Markings and homologations	CE cULus EAC	

Code	PRSL1002PI	PRSL1003PI
Utilisation category	AC 15	
Rated operational current	3 A	
Rated operational voltage	250 Vac	
Rated thermal current	10 A	
Rated insulation voltage	500 Vac	
Mechanical life	1x10 ⁶ operations	
Connections	Screw-type terminals	
Wires	1x2.5 mm ² , 2x1.5 mm ² (UL - (c)UL: use 60°C or 75°C copper (CU) conductor and wire 16-18 AWG)	
Tightening torque	0.6 Nm	
Microswitch type	Double switch, 1 speed	Double switch, 2 speeds
Contacts	2NO+common	3NO+common
Scheme		
Markings and homologations	CE cULus ENEC	

TECHNICAL SPECIFICATIONS OF THE LAMP HOLDERS

Code	PRSL1004PI
Maximum voltage	125 V
Maximum power	2.6 W
Lamp type	T5.5K 22 mm
Connections	Screw-type terminals
Wires	1x2.5 mm ² , 2x1.5 mm ²
Tightening torque	0.6 Nm
Markings and homologations	CE

OVERALL DIMENSIONS (mm)

With cable clamp M20

2

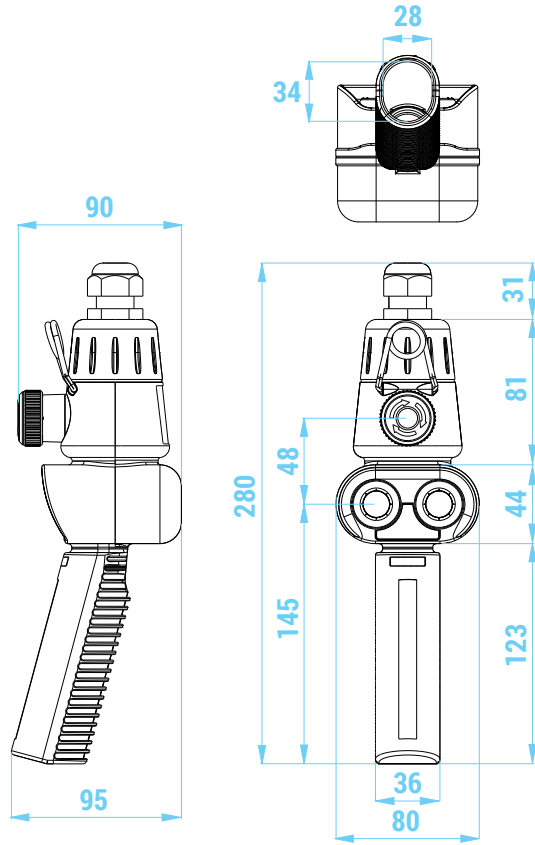



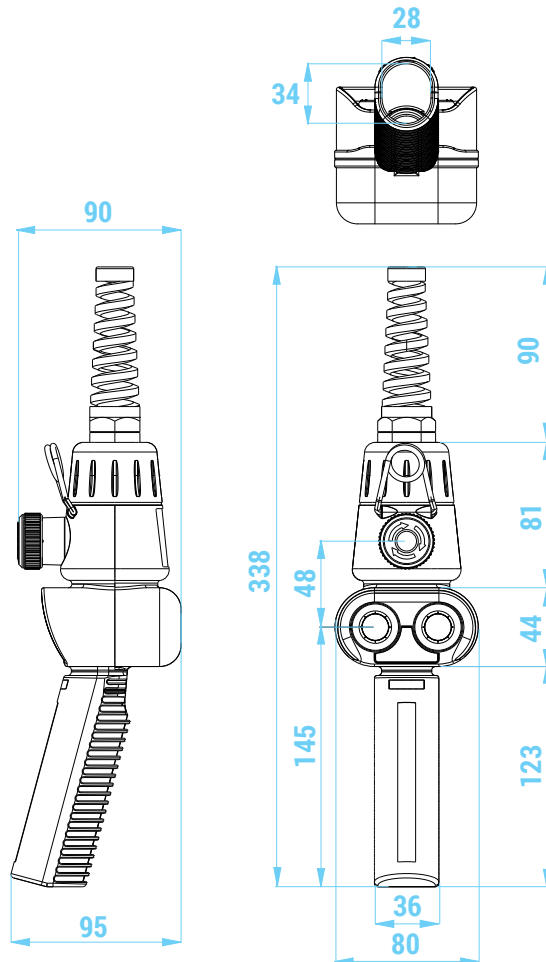

With spiral cable clamp M20





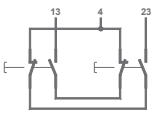

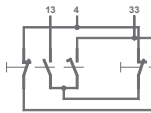

STANDARD CONTROL STATIONS

Standard control stations are equipped with cable clamp M20, hook and electrical interlock between opposite function pushbuttons.

2 actuators

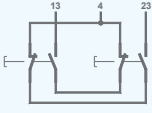
PF39020001			PF39020002		
Switch scheme	Switch type	Actuator type	Switch scheme	Switch type	Actuator type
	PRSL1002PI 2NO+common 1 speed	Pushbutton Pushbutton 		PRSL1003PI 3NO+common 2 speeds	Pushbutton Pushbutton 

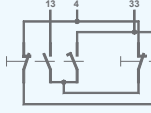
3 actuators

PF39030001			PF39030002		
Switch scheme	Switch type	Actuator type	Switch scheme	Switch type	Actuator type
	PRSL1001PI 1NC	Latched mushroom pushbutton		PRSL1001PI 1NC	Latched mushroom pushbutton
	PRSL1002PI 2NO+common 1 speed	Pushbutton Pushbutton 		PRSL1003PI 3NO+common 2 speeds	Pushbutton Pushbutton 

ASSEMBLY DRAWING



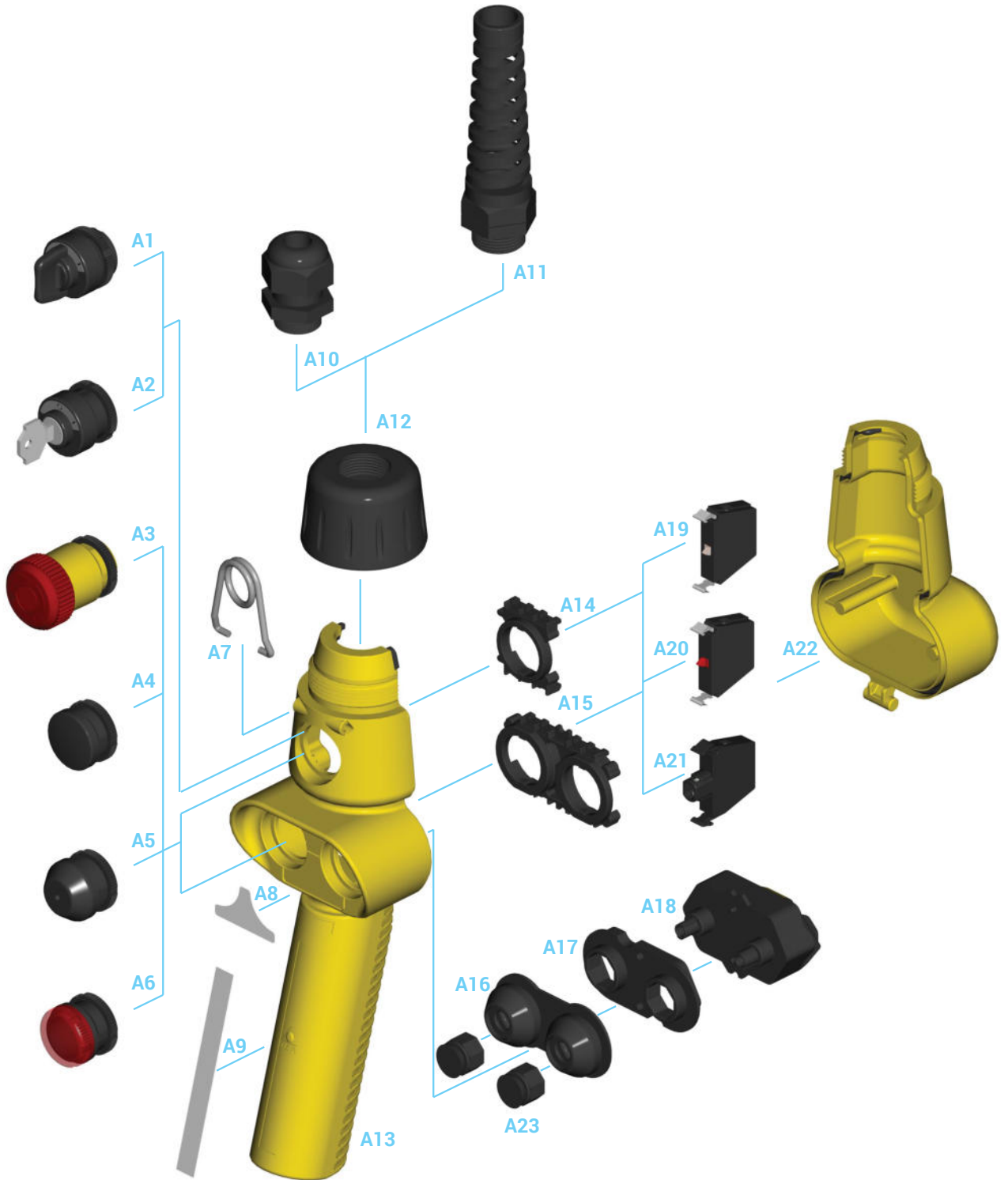



2



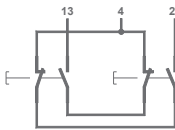
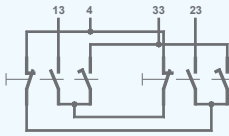



Refer to the following tables for descriptions of components: "Switches", "Actuators", "Pilot lights", "Mushroom pushbuttons", "Selector switches" and "Accessories".

COMPONENTS

Switches

Ref.	Drawing	Description	Scheme	Code
A18		1 speed, 2NO+common double switch		PRSL1002PI
		2 speeds, 3NO+common double switch		PRSL1003PI
A19		1NO switch		PRSL1000PI
A20		1NC switch		PRSL1001PI
A21		Lamp holder	-	PRSL1004PI

Actuators

Ref.	Drawing	Description	Code
A4		Blanking plug	PRSL1023PI
A5		Single pushbutton	PRTS000001
A16		Rubber for double pushbutton	PRGO0020PE
A16+A23		Double pushbutton with rubber	PRTD000001
A17		Holding plate for double pushbutton	PRSL8737PI

Pilot lights

Ref.	Drawing	Color	Code
A6		Red	PRSL1012PI
		Yellow	PRSL1013PI
		Green	PRSL1014PI













Mushroom pushbuttons

Ref.	Drawing	Description	Code
A3		Latched mushroom pushbutton for emergency stop	PRSL1009PI

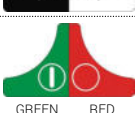
Selector switches

Ref.	Drawing	Positions	Spring return	Maintained positions	Pull-out position	Code
A1		0/1	X			PRSL1015PI
		0/1		X		PRSL1016PI
		1/0/2	X			PRSL1026PI
		1/0/2		X		PRSL1027PI
A2		0/1		X	0	PRSL1017PI
		0/1	X		0	PRSL1024PI

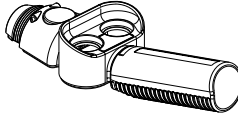
Accessories

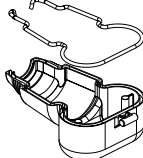
Ref.	Drawing	Description	Code
A7		Hook	PRGA0015PE
A8		Label	ET39030001
		Label	ET39030021
		Label	ET39030014
		Label	ET39030069
		Label	ET39030015
		Label	ET39030007
A9		Blank label for handle	PRET0127PE
A10		Cable clamp M20	PRPS0064PE
A11		Spiral cable clamp M20	PRPS0025PE
A12		Closing ring for cable clamp and spiral cable clamp	PRSL5524PI
A13		Cover	PRSL5008PI
A14		Holding plate for 3 switches	PRSL8739PI
A15		Holding plate for 2+2 switches	PRSL8735PI
A22		Enclosure	PRSL5518PI

