

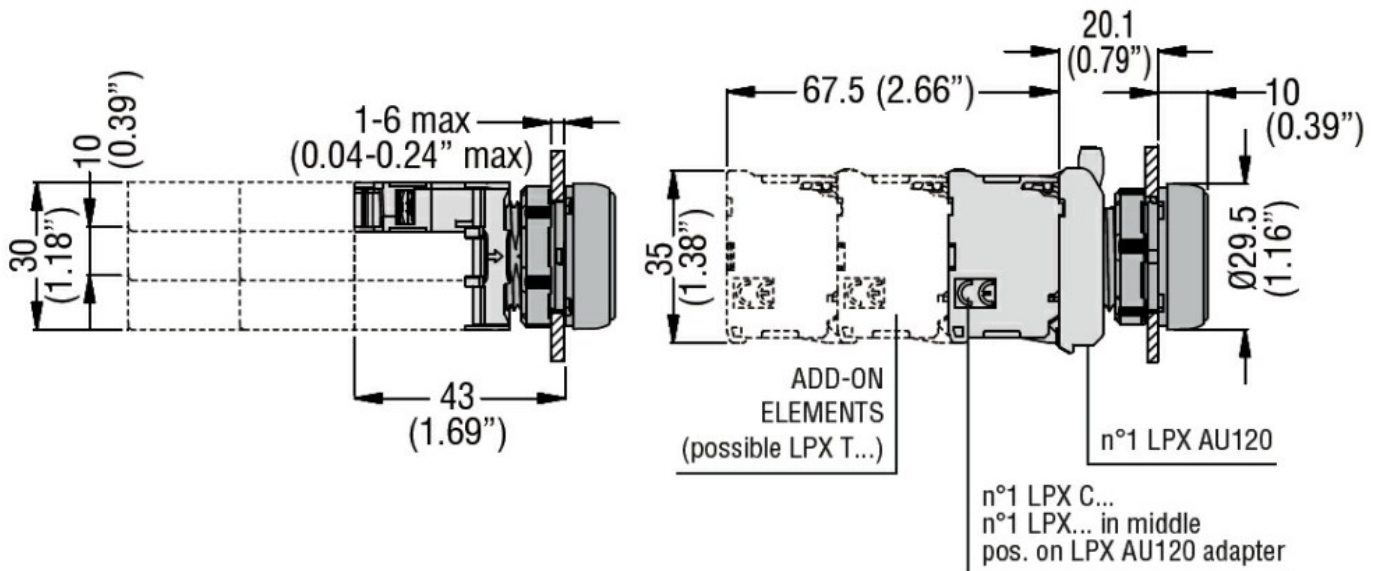

Product designation	LED elements steady light LPXLP		
Product type designation	LPXLP		
General characteristics			
Colour	White		
Electrical characteristics			
Supply voltage (AC)	V	12...30	
Supply voltage (DC)	V	12...30	
Operations			
Electrical life	hours	100000	
Mechanical features			
Tightening torque for terminals max	Nm	1	
Conductor section	AWG/kcmil conductor section		
	max	12	
	IEC		
	max	mm ²	1 or 2 / 2.5
Mounting adapter	LPXAU120		
Weight	g	16	
Ambient conditions			
Temperature			
Operating temperature			
	min	°C	-25
	max	°C	+70
Storage temperature			
	min	°C	-40
	max	°C	+85

Dimensions



Wiring diagrams



Certifications and compliance

Compliance

CSA C22.2 n° 14
IEC/EN/BS 60947-1
IEC/EN/BS 60947-5-1
UL508

Certificates

CCC
cULus
EAC
RINA
UL

ETIM classification

ETIM 8.0

EC000204 -
Lamp holder
block for control
circuit devices