

## D-SERIES DRM DRM270524LT

**Weidmüller Interface GmbH & Co. KG**  
 Klingenbergstraße 26  
 D-32758 Detmold  
 Germany  
 Fon: +49 5231 14-0  
 Fax: +49 5231 14-292083  
 www.weidmueller.com

### Product image



Similar to illustration

Relay from the D-SERIES DRM.

- 2 or 4 CO contacts
- Compact design
- Wide range of coil voltages
- Optional test button (AC red, DC blue)
- Optional with integrated status display (AC red, DC green)  
and/or free-wheel diode

### General ordering data

Type	DRM270524LT
Order No.	<a href="#">7760056073</a>
Version	D-SERIES DRM, Relay, Number of contacts: 2, CO contact with test button, AgNi 0,15 µm Au, Rated control voltage: 24 V AC, Continuous current: 10 A, Plug-in connection
GTIN (EAN)	4032248855827
Qty.	20 pc(s).

Creation date July 9, 2020 9:04:32 AM CEST

Catalogue status 09.07.2020 / We reserve the right to make technical changes.

**D-SERIES DRM**  
**DRM270524LT**

**Weidmüller Interface GmbH & Co. KG**  
 Klingenbergstraße 26  
 D-32758 Detmold  
 Germany  
 Fon: +49 5231 14-0  
 Fax: +49 5231 14-292083  
 www.weidmueller.com

**Technical data**
**Dimensions and weights**

Width	21 mm	Width (inches)	0.827 inch
Height	27.4 mm	Height (inches)	1.079 inch
Depth	35.7 mm	Depth (inches)	1.406 inch
Net weight	35.15 g		

**Temperatures**

Humidity	35...85 % rel. humidity, no condensation	Operating temperature, max.	55 °C
Operating temperature, min.	-40 °C	Storage temperature, max.	70 °C
Storage temperature, min.	-40 °C	Operating temperature	-40 °C...55 °C
Storage temperature	-40 °C...70 °C		

**Environmental Product Compliance**

REACH SVHC	Lead 7439-92-1
------------	----------------

**Rated data UL**

Certificate No. (cURus)	E312083
-------------------------	---------

**Input**

Rated control voltage	24 V AC	Rated current AC	62.4 mA (50 Hz), 52.2 mA (60 Hz)
Power rating	1.0...1.2VA (60HZ)	Pull-in/drop-out voltage, typ.	19.2 V / 7.2 V AC
Coil resistance	160 Ω ± 10 %	Status indicator	red LED

**Output**

Rated switching voltage	250 V AC	Max. switching voltage, AC	250 V
Continuous current	10 A	Inrush current	20 A / 50 ms
AC switching capacity (resistive), max.	2500 VA	DC switching capacity (resistive), max.	240 W @ 24 V
Switch-on delay	< 20 ms	Switch-off delay	< 20 ms
Min. switching power	10 mA @ 12 V, 100 mA @ 5 V	Max. switching frequency at rated load	0.1 Hz

**Contact data**

Contact type	2 CO contact with test button (AgNi 0,15 µm Au)	Contact resistance	≤ 50 mΩ
Mechanical service life	20 x 10 <sup>6</sup> switching cycles		

**General data**

Test button	yes (lockable)	Mechanical switch position indicator	Yes
Colour	Transparent	UL 94 flammability rating	V-2

**D-SERIES DRM  
DRM270524LT**

**Weidmüller Interface GmbH & Co. KG**  
Klingenbergstraße 26  
D-32758 Detmold  
Germany  
Fon: +49 5231 14-0  
Fax: +49 5231 14-292083  
www.weidmueller.com

**Technical data**

**Insulation coordination**

Rated voltage	250 V	Surge voltage category	III
Pollution severity	2	Protection degree	IP20
Dielectric strength, Input/Output	1.8 kV <sub>eff</sub> / 1 min.	Creepage and clearance distance input – output	≥ 5.5 mm
Dielectric strength of neighbouring contacts	1 kV <sub>eff</sub> / 1 min	Dielectric strength of open contact	1 kV <sub>eff</sub> / 1 min
Impulse withstand voltage	6 kV (1.2/50 µs)		

**Further details of approvals / standards**

Standards	IEC 61810-1, EN 60664-1:2007, EN 61000-6-2:2005, EN 61000-6-4:2007 + A1:2011, UL 508	Certificate No. (cURus)	E312083
-----------	--------------------------------------------------------------------------------------	-------------------------	---------

**Connection data**

Wire connection method	Plug-in connection
------------------------	--------------------

**Classifications**

ETIM 6.0	EC001437	ETIM 7.0	EC001437
eClass 9.0	27-37-16-01	eClass 9.1	27-37-16-01
eClass 10.0	27-37-16-01		

**Approvals**

Approvals



ROHS	Conform
------	---------

**Downloads**

Approval/Certificate/Document of Conformity	<a href="#">EU Konformitätserklärung / EU Declaration of Conformity</a>
Brochure/Catalogue	<a href="#">CAT 4.2 ELECTR 18/19 EN</a>
Engineering Data	<a href="#">EPLAN, WSCAD</a>
Engineering Data	<a href="#">STEP</a>

**D-SERIES DRM  
DRM270524LT**

**Weidmüller Interface GmbH & Co. KG**  
 Klingenbergstraße 26  
 D-32758 Detmold  
 Germany  
 Fon: +49 5231 14-0  
 Fax: +49 5231 14-292083  
 www.weidmueller.com

**Drawings**

**Wiring diagram**

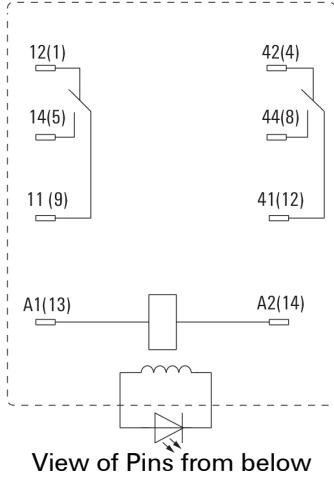

**Graph**

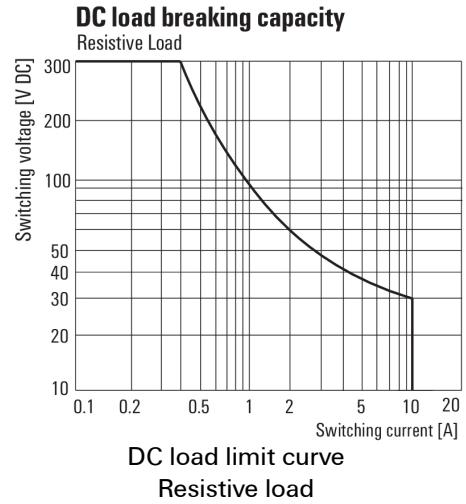

**Graph**

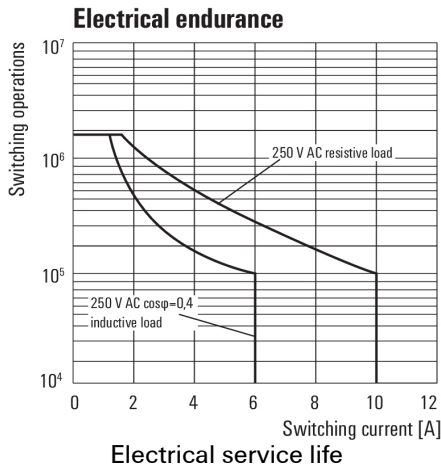

**Graph**

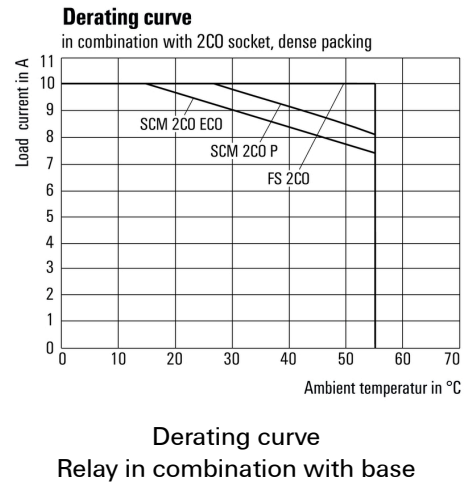

**Graph**

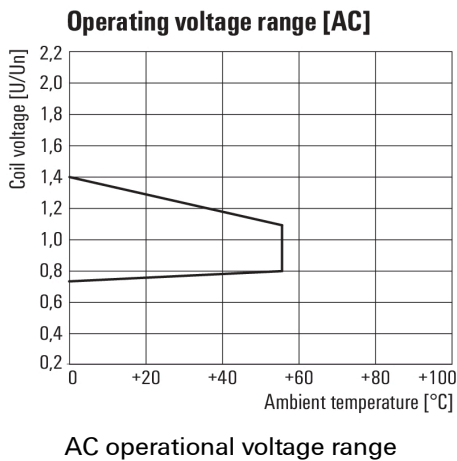

**Dimensional drawing**

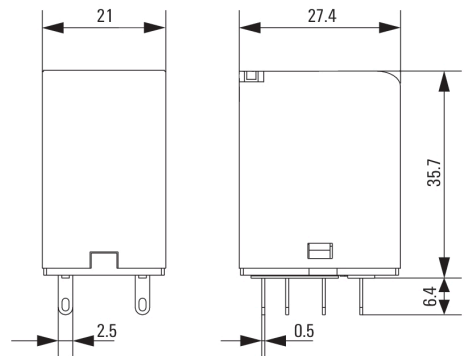

**Data sheet**

**D-SERIES DRM  
DRM270524LT**

**Weidmüller Interface GmbH & Co. KG**  
 Klingenbergstraße 26  
 D-32758 Detmold  
 Germany  
 Fon: +49 5231 14-0  
 Fax: +49 5231 14-292083  
 www.weidmueller.com

**Drawings**

**Miscellaneous**

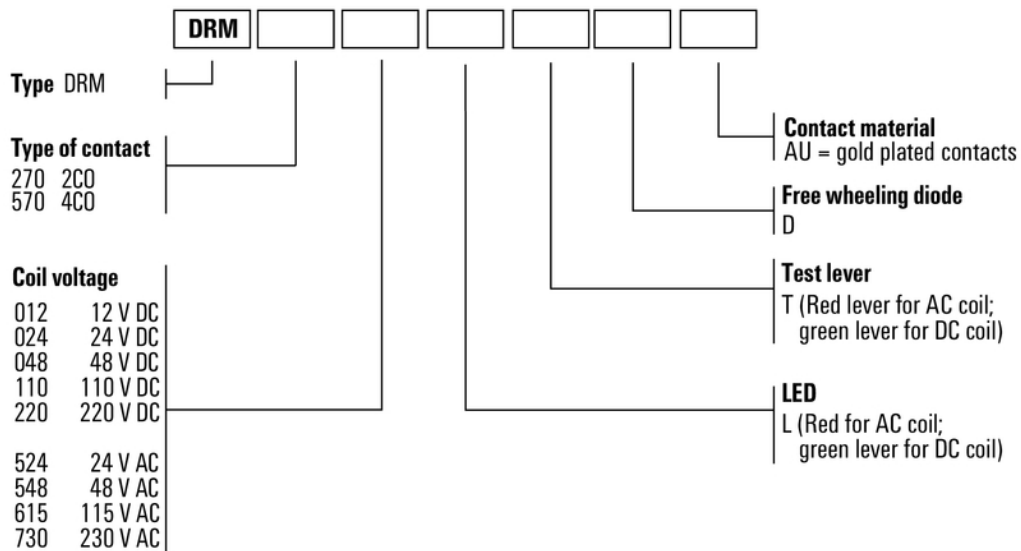

Type codes