











Illuminable selector switch, 22 mm, round, metal shiny, black, Selector switch long, 2 switch positions O<I, momentary contact type, Actuating angle 45°, 10:30h/12h

product brand name	SIRIUS ACT
product designation	Selector switches
design of the product	Actuating/signaling element
product type designation	3SU1
product line	Metal, shiny, 22 mm
<b>Enclosure</b>	
number of command points	1
<b>Actuator</b>	
design of the actuating element	selector, long
principle of operation of the actuating element	momentary contact, 45° (10:30 h/12 h), return from center to left
product extension optional	
• light source	Yes
• contact module	Yes
color of the actuating element	black
material of the actuating element	plastic
shape of the actuating element	Handle
outer diameter of the actuating element	44.8 mm
number of switching positions	2
actuating angle	
• clockwise	45°
<b>Front ring</b>	
product component front ring	Yes
design of the front ring	standard
material of the front ring	Metal, high gloss
color of the front ring	silver
<b>General technical data</b>	
protection class IP	IP66, IP67, IP69(IP69K)
degree of protection NEMA rating	1, 2, 3, 3R, 4, 4X, 12, 13
shock resistance	
• according to IEC 60068-2-27	sinusoidal half-wave 15g / 11 ms
vibration resistance	
• according to IEC 60068-2-6	10 ... 500 Hz: 5g
operating frequency maximum	1 800 1/h
mechanical service life (operating cycles) typical	1 000 000
reference code according to IEC 81346-2	S
Substance Prohibitance (Date)	03/01/2017
<b>Safety related data</b>	
proportion of dangerous failures	
• with low demand rate according to SN 31920	20 %
• with high demand rate according to SN 31920	20 %

failure rate [FIT] with low demand rate according to SN 31920	100 FIT
B10 value with high demand rate according to SN 31920	500 000
<b>IEC 62061</b>	
T1 value for proof test interval or service life according to IEC 61508	20 a
<b>Ambient conditions</b>	
ambient temperature	
• during operation	-25 ... +70 °C
• during storage	-40 ... +80 °C
environmental category during operation according to IEC 60721	3M6, 3S2, 3B2, 3C3, 3K6 (with relative air humidity of 10 ... 95%)
<b>Environmental footprint</b>	
Environmental Product Declaration(EPD)	Yes
Global Warming Potential [CO2 eq] total	0.593 kg
Global Warming Potential [CO2 eq] during manufacturing	0.625 kg
Global Warming Potential [CO2 eq] during operation	0.235 kg
Global Warming Potential [CO2 eq] after end of life	-0.267 kg
<b>Installation/ mounting/ dimensions</b>	
height	44.8 mm
width	44.8 mm
shape of the installation opening	round
mounting diameter	22.3 mm
positive tolerance of installation diameter	0.4 mm
mounting height	28.8 mm
installation width	44.8 mm
installation depth	25.4 mm
<b>Approvals Certificates</b>	
General Product Approval	Declaration of Conformity
	<a href="#">Confirmation</a>
	
	
	EG-Konf.
	
<b>Test Certificates</b>	
<a href="#">Type Test Certificates/Test Report</a>	<a href="#">Special Test Certificate</a>
	
ABS	LRS
	
PRS	RINA
<b>other</b>	
<a href="#">Confirmation</a>	<a href="#">Environmental Confirmations</a>
<b>Further information</b>	
<p>Siemens has decided to exit the Russian market (see here).  <a href="https://press.siemens.com/global/en/pressrelease/siemens-wind-down-russian-business">https://press.siemens.com/global/en/pressrelease/siemens-wind-down-russian-business</a></p> <p>Siemens is working on the renewal of the current EAC certificates.  Please contact your local Siemens office on the status of validity of the EAC certification if you intend to import or offer to supply these products to an EAC relevant market (other than the sanctioned EAEU member states Russia or Belarus).</p> <p>Information on the packaging  <a href="https://support.industry.siemens.com/cs/ww/en/view/109813875">https://support.industry.siemens.com/cs/ww/en/view/109813875</a></p> <p>Information- and Downloadcenter (Catalogs, Brochures,...)  <a href="https://www.siemens.com/ic10">https://www.siemens.com/ic10</a></p> <p>Industry Mall (Online ordering system)  <a href="https://mall.industry.siemens.com/mall/en/en/Catalog/product?mlfb=3SU1052-2CC10-0AA0">https://mall.industry.siemens.com/mall/en/en/Catalog/product?mlfb=3SU1052-2CC10-0AA0</a></p> <p>Cax online generator  <a href="http://support.automation.siemens.com/WW/CAXorder/default.aspx?lang=en&amp;mlfb=3SU1052-2CC10-0AA0">http://support.automation.siemens.com/WW/CAXorder/default.aspx?lang=en&amp;mlfb=3SU1052-2CC10-0AA0</a></p> <p>Service&amp;Support (Manuals, Certificates, Characteristics, FAQs,...)</p>	

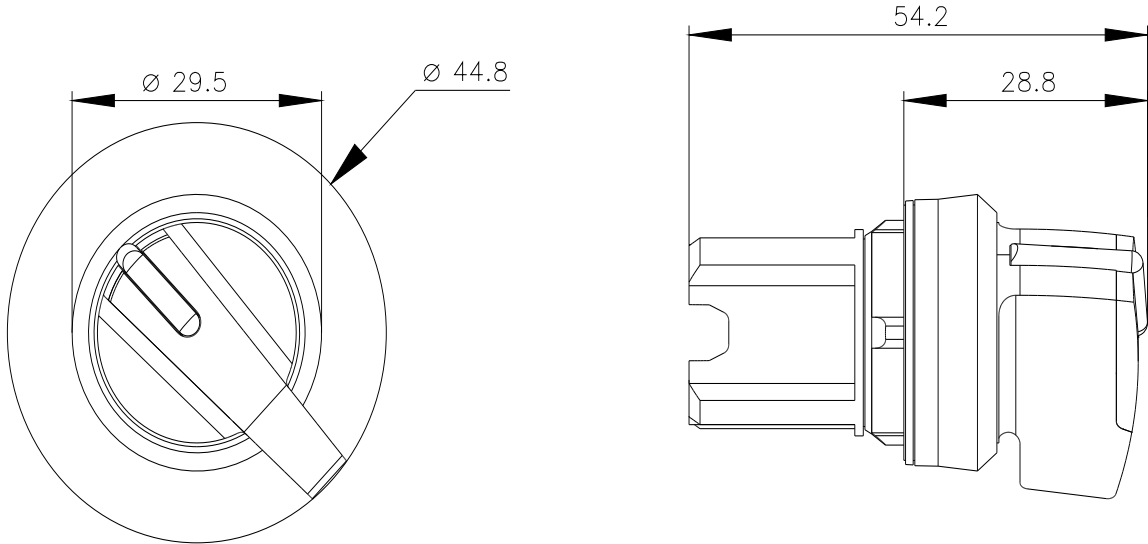

---

last modified:

11/4/2023 