



RONIS key-operated switch, 22 mm, round, metal, shiny, lock number SB30, with 2 keys, 3 switch positions I-O-II, latching, actuating angle 2x45°, 10:30h/12h/13:30h, key removal O+I, possible special locks: SB31, 421, 455

product brand name	SIRIUS ACT
product designation	Key-operated switches
design of the product	Actuating/signaling element
product type designation	3SU1
product line	Metal, shiny, 22 mm
manufacturer's article number of included key	<a href="#">3SU1950-0FB80-0AA0</a>
<b>Actuator</b>	
principle of operation of the actuating element	latching, 2x45° (10:30 h/12 h/13:30 h)
product extension optional light source	No
color	
• of the actuating element	silver
material of the actuating element	metal
shape of the actuating element	Key
outer diameter of the actuating element	29.5 mm
number of switching positions	3
switch position for key distraction	O+I
actuating angle	
• clockwise	45°
• anticlockwise	45°
lock make	RONIS
key number	SB30
<b>Front ring</b>	
product component front ring	Yes
design of the front ring	Standard
material of the front ring	Metal, high gloss
color of the front ring	silver
<b>General technical data</b>	
protection class IP	IP66, IP67, IP69(IP69K)
• of the terminal	IP20
degree of protection NEMA rating	1, 2, 3, 3R, 4, 4X, 12, 13
shock resistance	
• according to IEC 60068-2-27	sinusoidal half-wave 15g / 11 ms
vibration resistance	
• according to IEC 60068-2-6	10 ... 500 Hz: 5g
operating frequency maximum	1 800 1/h
mechanical service life (operating cycles) typical	300 000
reference code according to IEC 81346-2	S
Substance Prohibitance (Date)	10/01/2014
<b>Ambient conditions</b>	
ambient temperature	

<ul style="list-style-type: none"> <li>during operation</li> <li>during storage</li> </ul>	-25 ... +70 °C -40 ... +80 °C
environmental category during operation according to IEC 60721	3M6, 3S2, 3B2, 3C3, 3K6 (with relative air humidity of 10 ... 95%)





### Environmental footprint

Environmental Product Declaration(EPD)	Yes
Global Warming Potential [CO2 eq] total	0.593 kg
Global Warming Potential [CO2 eq] during manufacturing	0.625 kg
Global Warming Potential [CO2 eq] during operation	0.235 kg
Global Warming Potential [CO2 eq] after end of life	-0.267 kg



### Installation/ mounting/ dimensions

height	29.5 mm
width	29.5 mm
shape of the installation opening	round
mounting diameter	22.3 mm
positive tolerance of installation diameter	0.4 mm
mounting height	49.4 mm
installation width	29.5 mm
installation depth	25.4 mm

### Approvals Certificates

General Product Approval	Declaration of Conformity
 <a href="#">Confirmation</a>	   

### Test Certificates

Test Certificates	Marine / Shipping
<a href="#">Type Test Certificates/Test Report</a>	<a href="#">Special Test Certificate</a>
	   

### other

Environment
<a href="#">Confirmation</a>
<a href="#">Environmental Confirmations</a>

### Further information

Siemens has decided to exit the Russian market (see here).  
<https://press.siemens.com/global/en/pressrelease/siemens-wind-down-russian-business>

Siemens is working on the renewal of the current EAC certificates.  
Please contact your local Siemens office on the status of validity of the EAC certification if you intend to import or offer to supply these products to an EAC relevant market (other than the sanctioned EAEU member states Russia or Belarus).

Information on the packaging  
<https://support.industry.siemens.com/cs/ww/en/view/109813875>

Information- and Downloadcenter (Catalogs, Brochures,...)  
<https://www.siemens.com/ic10>

Industry Mall (Online ordering system)  
<https://mall.industry.siemens.com/mall/en/en/Catalog/product?mifb=3SU1050-4BL51-0AA0>

Cax online generator  
<https://support.automation.siemens.com/WW/CAXorder/default.aspx?lang=en&mifb=3SU1050-4BL51-0AA0>

Service&Support (Manuals, Certificates, Characteristics, FAQs,...)  
<https://support.industry.siemens.com/cs/ww/en/ps/3SU1050-4BL51-0AA0>

Image database (product images, 2D dimension drawings, 3D models, device circuit diagrams, EPLAN macros, ...)  
[http://www.automation.siemens.com/bilddb/cax\\_de.aspx?mifb=3SU1050-4BL51-0AA0&lang=en](http://www.automation.siemens.com/bilddb/cax_de.aspx?mifb=3SU1050-4BL51-0AA0&lang=en)

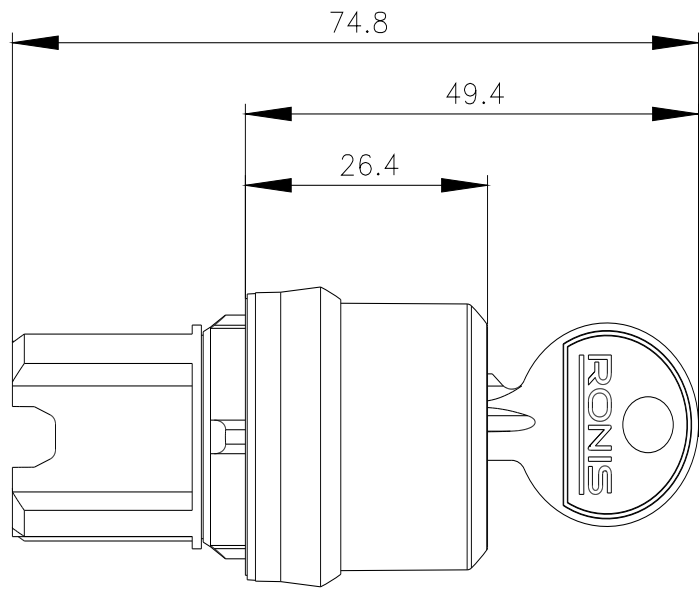
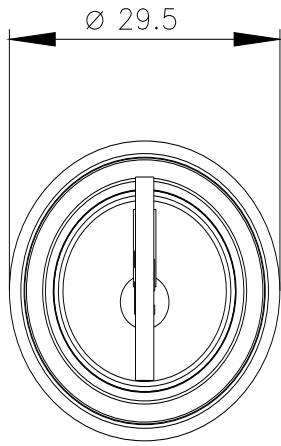

---

last modified:

11/7/2023 