











key-operated switch Siemens, 22 mm, round, plastic, lock number SSG10, with 2 keys, 2 switch positions O-I, latching, actuating angle 90°, 10:30h/13:30h, key removal O

product brand name	SIRIUS ACT
product designation	Key-operated switches
design of the product	Actuating/signaling element
product type designation	3SU1
product line	Plastic, black, 22 mm
manufacturer's article number of included key	<a href="#">3SU1950-0FP80-0AA0</a>
<b>Actuator</b>	
principle of operation of the actuating element	latching, 90° (10:30 h/13:30 h)
product extension optional light source	No
color	
• of the actuating element	silver
material of the actuating element	metal
shape of the actuating element	Key
outer diameter of the actuating element	29.5 mm
number of switching positions	2
switch position for key distraction	O
actuating angle	
• clockwise	90°
lock make	Siemens
key number	SSG10
<b>Front ring</b>	
product component front ring	Yes
design of the front ring	Standard
material of the front ring	plastic
color of the front ring	black
<b>General technical data</b>	
protection class IP	IP66, IP67, IP69(IP69K)
• of the terminal	IP20
degree of protection NEMA rating	1, 2, 3, 3R, 4, 4X, 12, 13
shock resistance	
• according to IEC 60068-2-27	sinusoidal half-wave 15g / 11 ms
• for railway applications according to EN 61373	Category 1, Class B
operating frequency maximum	1 800 1/h
mechanical service life (operating cycles) typical	1 000 000
reference code according to IEC 81346-2	S
Substance Prohibitance (Date)	10/01/2014
<b>Safety related data</b>	
B10 value with high demand rate according to SN 31920	100 000
proportion of dangerous failures	
• with low demand rate according to SN 31920	20 %

• with high demand rate according to SN 31920	20 %
failure rate [FIT] with low demand rate according to SN 31920	100 FIT
<b>Ambient conditions</b>	
<b>ambient temperature</b>	
• during operation	-25 ... +70 °C
• during storage	-40 ... +80 °C
environmental category during operation according to IEC 60721	3M6, 3S2, 3B2, 3C3, 3K6 (with relative air humidity of 10 ... 95%)
<b>Environmental footprint</b>	
Environmental Product Declaration (EPD)	Yes
Global Warming Potential [CO2 eq] total	0.787 kg
Global Warming Potential [CO2 eq] during manufacturing	0.566 kg
Global Warming Potential [CO2 eq] during operation	0.235 kg
global warming potential [CO2 eq] after end of life	-0.015 kg
<b>Installation/ mounting/ dimensions</b>	
<b>height</b>	29.5 mm
<b>width</b>	29.5 mm
<b>shape of the installation opening</b>	round
<b>mounting diameter</b>	22.3 mm
<b>positive tolerance of installation diameter</b>	0.4 mm
<b>mounting height</b>	61 mm
<b>installation width</b>	29.5 mm
<b>installation depth</b>	25.4 mm
<b>Approvals Certificates</b>	
<b>General Product Approval</b>	<b>Declaration of Conformity</b>
 <a href="#">Confirmation</a>	   
<b>Test Certificates</b>	<b>Marine / Shipping</b>
<a href="#">Type Test Certificates/Test Report</a>	<a href="#">Special Test Certificate</a>
	   
<b>other</b>	<b>Environment</b>
<a href="#">Confirmation</a>	<a href="#">Environmental Confirmations</a>
<b>Further information</b>	
<p><b>Siemens has decided to exit the Russian market (see here).</b>  <a href="https://press.siemens.com/global/en/pressrelease/siemens-wind-down-russian-business">https://press.siemens.com/global/en/pressrelease/siemens-wind-down-russian-business</a></p> <p><b>Siemens is working on the renewal of the current EAC certificates.</b>  Please contact your local Siemens office on the status of validity of the EAC certification if you intend to import or offer to supply these products to an EAC relevant market (other than the sanctioned EAEU member states Russia or Belarus).</p> <p><b>Information on the packaging</b>  <a href="https://support.industry.siemens.com/cs/ww/en/view/109813875">https://support.industry.siemens.com/cs/ww/en/view/109813875</a></p> <p><b>Information- and Downloadcenter (Catalogs, Brochures,...)</b>  <a href="https://www.siemens.com/ic10">https://www.siemens.com/ic10</a></p> <p><b>Industry Mall (Online ordering system)</b>  <a href="https://mall.industry.siemens.com/mall/en/en/Catalog/product?mlfb=3SU1000-5BF01-0AA0">https://mall.industry.siemens.com/mall/en/en/Catalog/product?mlfb=3SU1000-5BF01-0AA0</a></p> <p><b>Cax online generator</b>  <a href="http://support.automation.siemens.com/WW/CAXorder/default.aspx?lang=en&amp;mlfb=3SU1000-5BF01-0AA0">http://support.automation.siemens.com/WW/CAXorder/default.aspx?lang=en&amp;mlfb=3SU1000-5BF01-0AA0</a></p> <p><b>Service&amp;Support (Manuals, Certificates, Characteristics, FAQs,...)</b>  <a href="https://support.industry.siemens.com/cs/ww/en/ps/3SU1000-5BF01-0AA0">https://support.industry.siemens.com/cs/ww/en/ps/3SU1000-5BF01-0AA0</a></p> <p><b>Image database (product images, 2D dimension drawings, 3D models, device circuit diagrams, EPLAN macros, ...)</b>  <a href="http://www.automation.siemens.com/bilddb/cax_de.aspx?mlfb=3SU1000-5BF01-0AA0&amp;lang=en">http://www.automation.siemens.com/bilddb/cax_de.aspx?mlfb=3SU1000-5BF01-0AA0&amp;lang=en</a></p>	

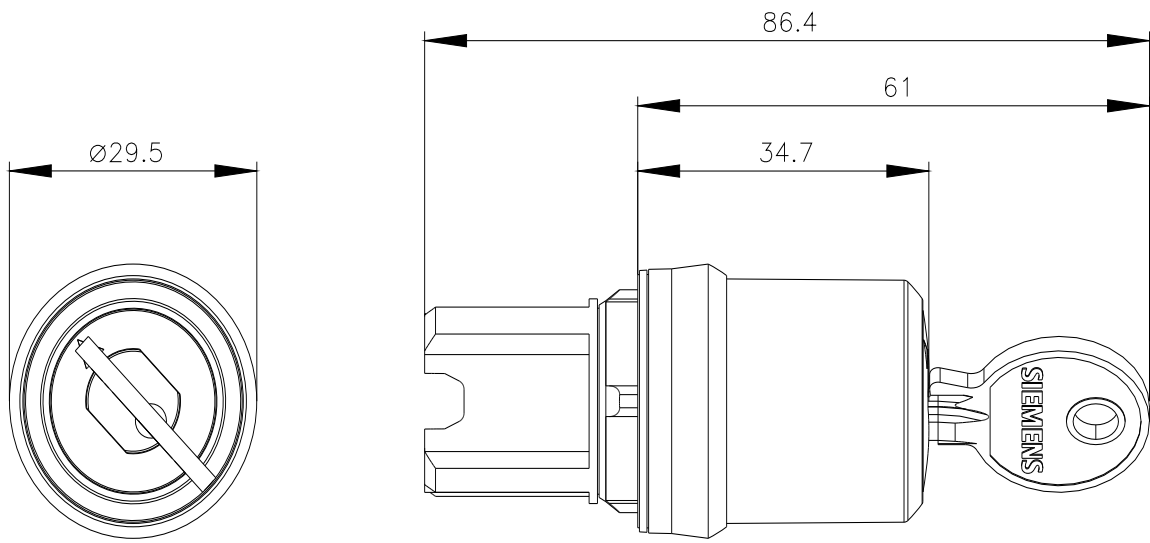

---

last modified:

11/7/2023 