



RONIS key-operated switch, 22 mm, round, plastic, lock number SB30, with 2 keys, 3 switch positions I-O-II, latching, actuating angle 2x45°, 10:30h/12h/13:30h, key removal O, possible special locks: SB31, 421, 455

product brand name	SIRIUS ACT
product designation	Key-operated switches
design of the product	Actuating/signaling element
product type designation	3SU1
product line	Plastic, black, 22 mm
manufacturer's article number of included key	3SU1950-0FB80-0AA0
Actuator	
principle of operation of the actuating element	latching, 2x45° (10:30 h/12 h/13:30 h)
product extension optional light source	No
color	
• of the actuating element	silver
material of the actuating element	metal
shape of the actuating element	Key
outer diameter of the actuating element	29.5 mm
number of switching positions	3
switch position for key distraction	O
actuating angle	
• clockwise	45°
• anticlockwise	45°
lock make	RONIS
key number	SB30
Front ring	
product component front ring	Yes
design of the front ring	Standard
material of the front ring	plastic
color of the front ring	black
General technical data	
protection class IP	IP66, IP67, IP69(IP69K)
• of the terminal	IP20
degree of protection NEMA rating	1, 2, 3, 3R, 4, 4X, 12, 13
shock resistance	
• according to IEC 60068-2-27	sinusoidal half-wave 15g / 11 ms
• for railway applications according to EN 61373	Category 1, Class B
operating frequency maximum	1 800 1/h
mechanical service life (operating cycles) typical	1 000 000
reference code according to IEC 81346-2	S
Substance Prohibitance (Date)	10/01/2014
Ambient conditions	
ambient temperature	
• during operation	-25 ... +70 °C

• during storage	-40 ... +80 °C
environmental category during operation according to IEC 60721	3M6, 3S2, 3B2, 3C3, 3K6 (with relative air humidity of 10 ... 95%)





Environmental footprint

Environmental Product Declaration(EPD)	Yes
Global Warming Potential [CO2 eq] total	0.787 kg
Global Warming Potential [CO2 eq] during manufacturing	0.566 kg
Global Warming Potential [CO2 eq] during operation	0.235 kg
global warming potential [CO2 eq] after end of life	-0.015 kg

Installation/ mounting/ dimensions

height	29.5 mm
width	29.5 mm
shape of the installation opening	round
mounting diameter	22.3 mm
positive tolerance of installation diameter	0.4 mm
mounting height	49.4 mm
installation width	29.5 mm
installation depth	25.4 mm

Approvals Certificates

General Product Approval	Declaration of Conformity
 Confirmation	   

Test Certificates

Test Certificates	Marine / Shipping
Special Test Certificate	Type Test Certificates/Test Report
	   

other

Environment
Confirmation
Environmental Confirmations

Further information

Siemens has decided to exit the Russian market (see here).
<https://press.siemens.com/global/en/pressrelease/siemens-wind-down-russian-business>

Siemens is working on the renewal of the current EAC certificates.
Please contact your local Siemens office on the status of validity of the EAC certification if you intend to import or offer to supply these products to an EAC relevant market (other than the sanctioned EAEU member states Russia or Belarus).

Information on the packaging
<https://support.industry.siemens.com/cs/ww/en/view/109813875>

Information- and Downloadcenter (Catalogs, Brochures,...)
<https://www.siemens.com/ic10>

Industry Mall (Online ordering system)
<https://mall.industry.siemens.com/mall/en/en/Catalog/product?mlfb=3SU1000-4BL01-0AA0>

Cax online generator
<http://support.automation.siemens.com/WW/CAXorder/default.aspx?lang=en&mlfb=3SU1000-4BL01-0AA0>

Service&Support (Manuals, Certificates, Characteristics, FAQs,...)
<https://support.industry.siemens.com/cs/ww/en/ps/3SU1000-4BL01-0AA0>

Image database (product images, 2D dimension drawings, 3D models, device circuit diagrams, EPLAN macros, ...)
http://www.automation.siemens.com/bilddb/cax_de.aspx?mlfb=3SU1000-4BL01-0AA0&lang=en

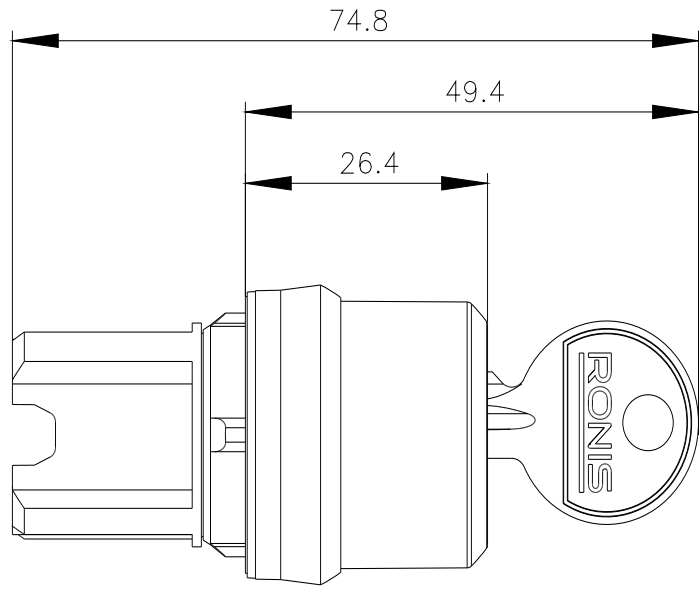
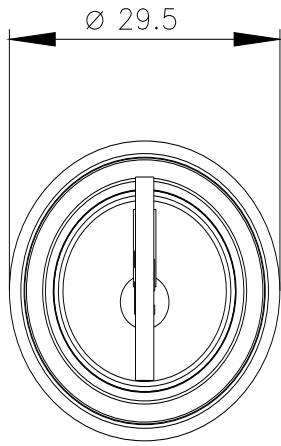

last modified:

11/7/2023 